

Troop 1292 # 116A

MERIT BADGE SERIES



WEATHER



BOY SCOUTS OF AMERICA®

BOY SCOUTS OF AMERICA
MERIT BADGE SERIES

WEATHER



HOW TO USE THIS PAMPHLET

The secret to successfully earning a merit badge is for you to use both the pamphlet and the suggestions of your counselor.

Your counselor can be as important to you as a coach is to an athlete. Use all of the resources your counselor can make available to you. This may be the best chance you will have to learn about this particular subject. Make it count.

If you or your counselor feels that any information in this pamphlet is incorrect, please let us know. Please state your source of information.

Merit badge pamphlets are reprinted annually and requirements updated regularly. Your suggestions for improvement are welcome.

Send comments along with a brief statement about yourself to Youth Development, S209 • Boy Scouts of America • 1325 West Walnut Hill Lane • P.O. Box 152079 • Irving, TX 75015-2079.

WHO PAYS FOR THIS PAMPHLET?

This merit badge pamphlet is one in a series of more than 100 covering all kinds of hobby and career subjects. It is made available for you to buy as a service of the national and local councils, Boy Scouts of America. The costs of the development, writing, and editing of the merit badge pamphlets are paid for by the Boy Scouts of America in order to bring you the best book at a reasonable price.



Requirements

1. Define meteorology. Explain what weather is and what climate is. Discuss how the weather affects farmers, sailors, aviators, and the outdoor construction industry. Tell why weather forecasts are important to each of these groups.
2. Name five dangerous weather-related conditions. Give the safety rules for each when outdoors and explain the difference between a severe weather watch and a warning. Discuss the safety rules with your family.
3. Explain the difference between high and low pressure systems in the atmosphere. Tell which is related to good and to poor weather. Draw cross sections of a cold front and a warm front, showing the location and movements of the cold and warm air, the frontal slope, the location and types of clouds associated with each type of front, and the location of precipitation.
4. Tell what causes wind, why it rains, and how lightning and hail are formed.
5. Identify and describe clouds in the low, middle, and upper levels of the atmosphere. Relate these to specific types of weather.
6. Draw a diagram of the water cycle and label its major processes. Explain the water cycle to your counselor.
7. Define acid rain. Identify which human activities pollute the atmosphere and the effects such pollution can have on people.

8. Do ONE of the following:

- a. Make one of the following instruments: wind vane, anemometer, rain gauge, hygrometer. Keep a daily weather log for one week using information from this instrument as well as from other sources such as local radio and television stations, NOAA Weather Radio, and Internet sources (with your parent's permission). Record the following information at the same time every day: wind direction and speed, temperature, precipitation, and types of clouds. Be sure to make a note of any morning dew or frost. In the log, also list the weather forecasts from radio or television at the same time each day and show how the weather really turned out.
- b. Visit a National Weather Service office or talk with a local radio or television weathercaster, private meteorologist, local agricultural extension service officer, or university meteorology instructor. Find out what type of weather is most dangerous or damaging to your community. Determine how severe weather and flood warnings reach the homes in your community.

9. Do ONE of the following:

- a. Give a talk of at least five minutes to a group (such as your unit or a Cub Scout pack) explaining the outdoor safety rules in the event of lightning, flash floods, and tornadoes. Before your talk, share your outline with your counselor for approval.
- b. Read several articles about acid rain and give a prepared talk of at least five minutes to a group (such as your unit or a Cub Scout pack) about the articles. Before your talk, share your outline with your counselor for approval.

10. Find out about a weather-related career opportunity that interests you. Discuss with and explain to your counselor what training and education are required for such a position, and the responsibilities required of such a position.

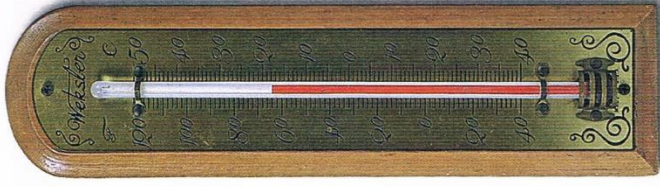

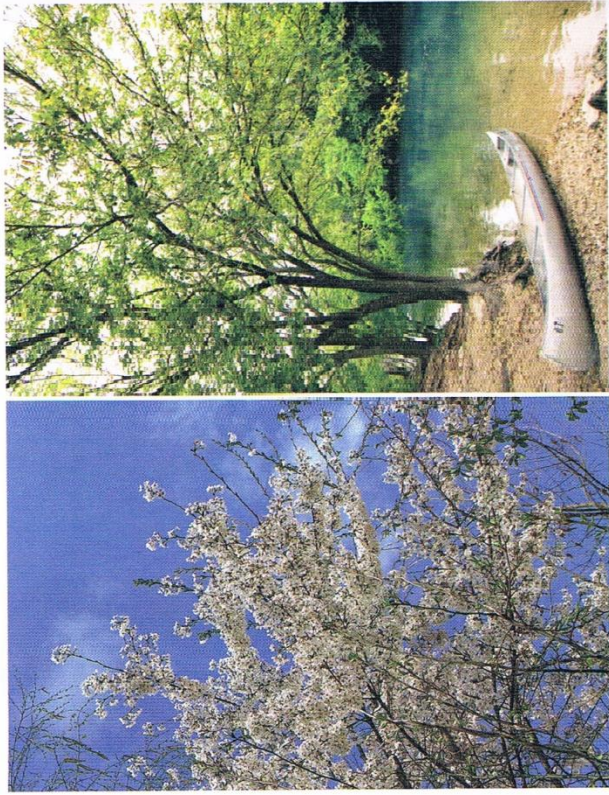

Contents

Earth and Its Atmosphere	7
Moisture—The Water Cycle	15
Clouds and Precipitation	21
Hazardous Weather	31
Measuring and Recording the Weather	41
Weather and Climate Prediction	63
Careers in Meteorology	73
Weather Resources	77

Earth and Its Atmosphere

Earth's atmosphere can be thought of as an ocean. It is an ocean of air instead of water. The air is almost never at rest. Its restless movement is the source of everything people call *weather*. The study of the atmosphere and its weather is the science of *meteorology*.

Elements of the Atmosphere

The atmosphere is a mixture of *gases*, six of which are present in amounts large enough to be important in studying meteorology. Four of the six stay more or less in constant proportions, at least in the atmosphere's lowest 8 miles or so. The most abundant of these is nitrogen, making up about 78 percent of the atmosphere. Oxygen is next, at about 21 percent, followed by argon at about 1 percent, and carbon dioxide at about 0.03 percent. Nitrogen, oxygen, and carbon dioxide are essential to life on Earth. If their proportions were to change significantly, all life would disappear.

The atmosphere contains two other important gases. Because their amounts change from time to time and place to place, they are called *variable gases*. One is water vapor, which can range from nearly zero to as high as about 4 percent of the total. Most of the water vapor is concentrated in the lowest mile of the atmosphere. When it condenses to form clouds, rain, and snow, it is the most important part of the weather.

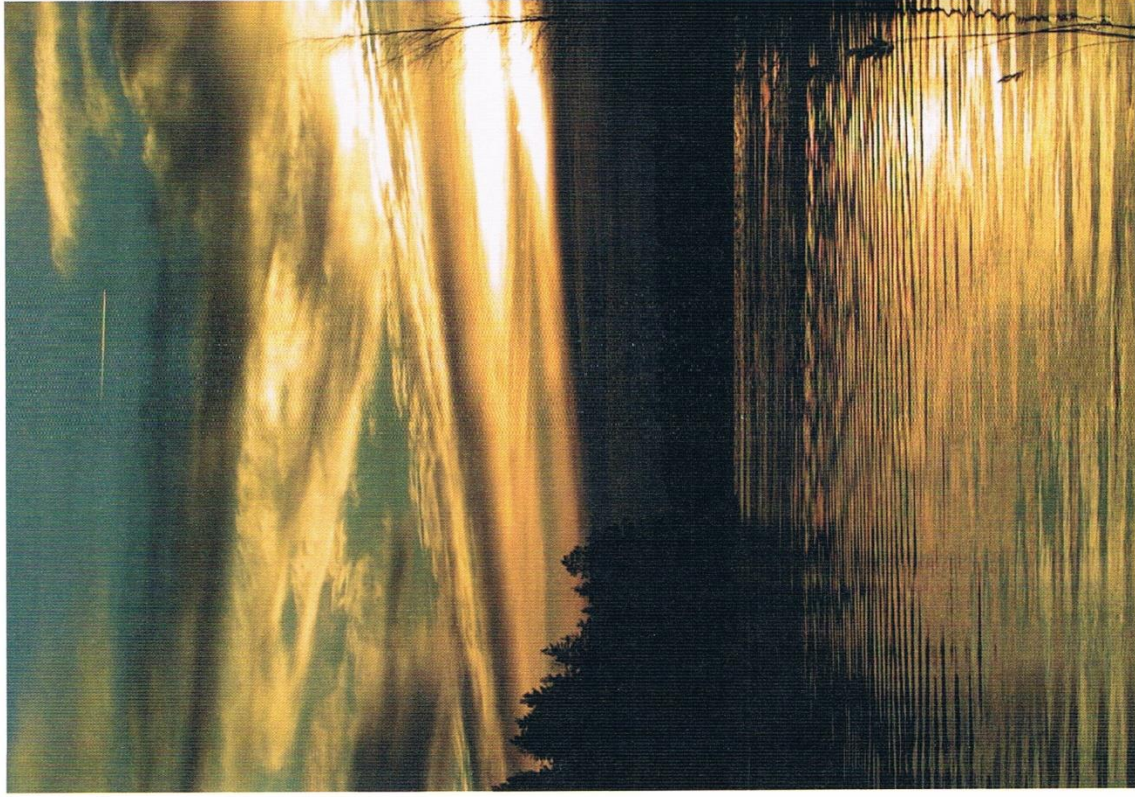
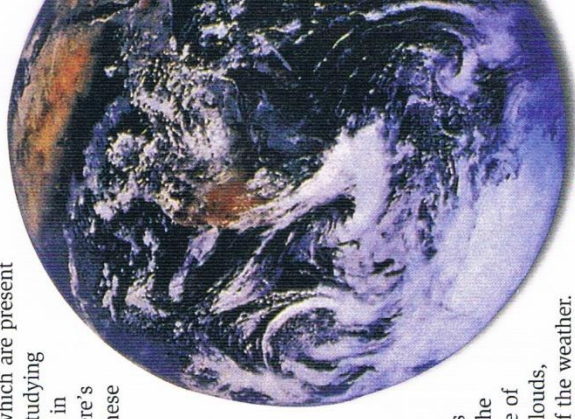

The other variable gas is ozone, most of which is found more than 6 miles above Earth. While ozone at sea level harms humans and plant life, its presence high in the atmosphere shields us from the sun's ultraviolet rays.

The Vertical Structure of the Atmosphere

A cross section of the atmosphere shows that it consists of four main layers. There is no "top" to Earth's atmosphere. Instead, it gradually thins until it vanishes into the vacuum of space.

The lowest layer of Earth's atmosphere is called the *troposphere*. This layer varies in depth from about 10 miles at the equator to only 4 miles over the North and South poles. It is within this layer that most weather occurs. The troposphere is constantly stirred by the motions that produce weather, so the mixture of gases is nearly constant. Earth's surface, which is warmed by the sun, in turn warms the air of the lower troposphere. As a result, temperatures in this layer tend to decrease as altitude increases. On average, for every 1,000 feet gained, the air temperature will decrease by roughly 3.5 degrees Fahrenheit.

The layer above the troposphere is the *stratosphere*. This layer extends to a height of about 30 miles. In the stratosphere, the atmosphere is quite thin and the mixture of gases begins to change. The small amount of ozone in the stratosphere is vital to life on Earth because it absorbs the sun's harmful ultraviolet radiation.

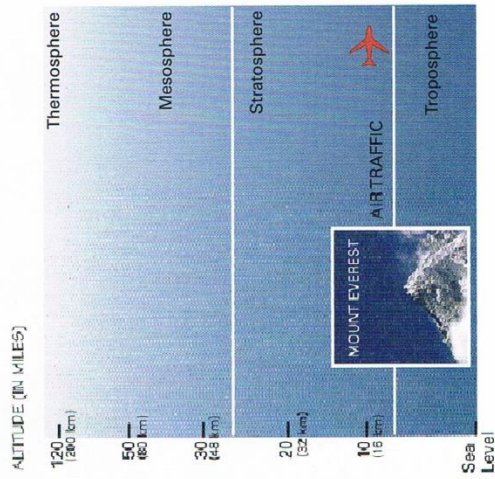

The boundary between the troposphere and stratosphere is called the *tropopause*, a lid on the weather-filled troposphere. Temperature begins to increase with height above the tropopause because an increasing number of ozone molecules absorb the sun's ultraviolet radiation.

Above the stratosphere is the *mesosphere*, which extends about 30 to 50 miles. Temperature decreases with height in this coldest layer of the atmosphere. The next layer is the *thermosphere*. Because of the sun's rays, air temperatures in this layer can reach more than 1,800 degrees.

The Origin of Wind

In prehistoric times, humans became aware that the weather—cloudy or clear skies, warm or cold air—depended on wind direction and speed. During the 1600s, people learned that air has weight. Scientists discovered that air becomes lighter when it is warm and heavier when it is cold. Because the pressure that anything exerts on the surface of Earth depends on its weight, air temperature affects air pressure.

Air temperature also is a factor in how winds arise. If air in one place is heated so that it is warmer than the air around it, that air tends to rise. As it does, air must flow in from around the heated region to replace the air that is rising.

Air has weight for the same reason you do. It is held to Earth by gravity. In fact, the air above a square inch of Earth's surface exerts 14.7 pounds of pressure at sea level. *Atmospheric pressure*, or air pressure, is the amount of force the air exerts on a unit surface area (an area that has equal length and width). Why don't you feel all that weight pressing down on you? One reason is that the air is not really pressing down but is pressing in all directions. Also, the air inside your body is pressing in all directions with equal pressure.



If you live near a seacoast, you may see this process operate every day. During the day, the land heats more rapidly than the ocean. This heat warms the air over the land and makes it rise. Cooler air from the ocean flows in to replace it. In turn, the rising air over land flows out to sea at some level above the surface to replace the air flowing inland. This creates a sea breeze.

At night, the opposite happens. The land cools more rapidly than the ocean. Air flows from land to sea at the surface, and the cycle is reversed. The circulation that results is a land breeze. Similar circulations can develop around mountains, creating mountain and valley breezes. The winds that create the weather all arise in this way, as a result of unequal heating. However, it is not always this easy to understand why winds behave the way they do.

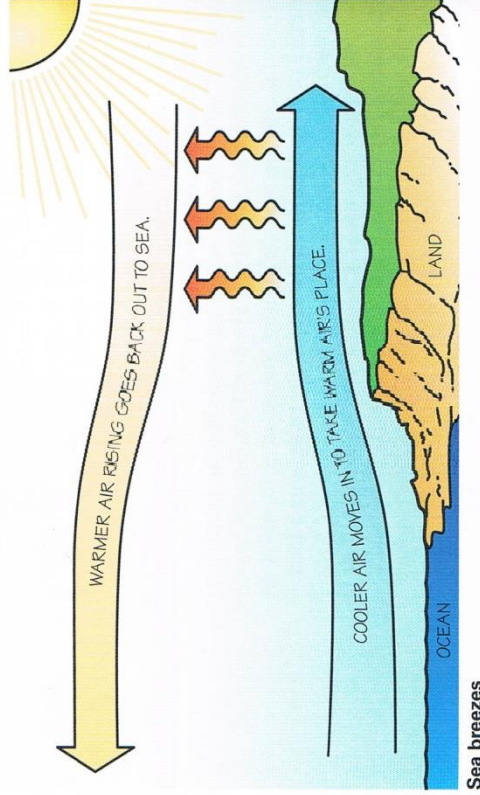

Sea breezes

The fact that sunlight does not evenly heat Earth's surface means that temperatures vary from place to place and from time to time. This difference in air temperature (and therefore air pressure) creates a force that makes the air move from high- to low-pressure regions, trying to equalize the pressure. When the motion of the moving air is vertical or nearly so, it is called a *current*. When the motion is more horizontal, it is called *wind*.

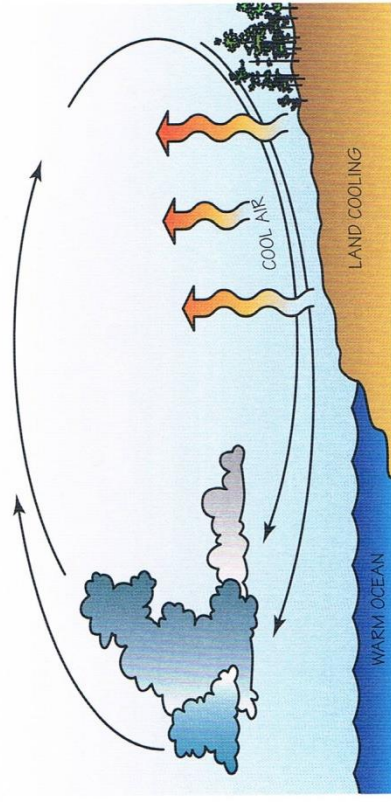

Land breezes

Global Wind and Pressure Systems

Warm air near the equator, in the tropics, tends to rise and flow toward the poles (poleward). Along the way, the air cools and begins to sink. Because the equatorial regions are warm, they tend to form a belt of relatively low pressure. The regions of sinking air tend to be associated with relatively high pressure, in what are called the "horse latitudes," or subtropics.

In a similar fashion, air over the poles tends to sink, being colder and heavier. This sinking sends the air flowing into the subtropical regions, where it warms and rises, forming a belt with relatively low pressure at the surface. (Remember, warm air brings about low pressure, and cold air brings about high pressure because it weighs more.)

The *middle latitudes* lie between the belt of subtropical lows and the subtropical highs. Most of the United States can be found in the Northern Hemisphere's middle latitudes. The Southern Hemisphere also has middle latitudes. Air tends to flow poleward at the surface of Earth, and toward the equator (equatorward) aloft, completing the transition between the polar and equatorial circulations.

The Relationship Between Wind and Pressure

To understand why global winds have both easterly and westerly movement, remember that Earth is rotating about its polar axis. It makes one complete turn in 24 hours, which causes day to alternate with night. The speed of rotation varies as you move north or south—it varies with *latitude*. You can see this on a globe. Spin the globe and watch while points near the equator move fast while the poles do not move at all. A point on Earth's equator travels more than 1,000 miles per hour (about 25,000 miles in 24 hours), while the poles do not move.

This difference in speed produces an interesting effect as seen by an observer watching things from Earth. Imagine firing a cannon due south. As the cannonball travels south, it passes over points that are moving more and more rapidly beneath it. Its path, *as seen on Earth* (the solid arrow), curves to the right. A mysterious force appears to make the path of the cannonball curve. An observer in space would see the path of the cannonball as a straight line (the dashed arrow in the diagram), but it appears curved to earthbound observers.

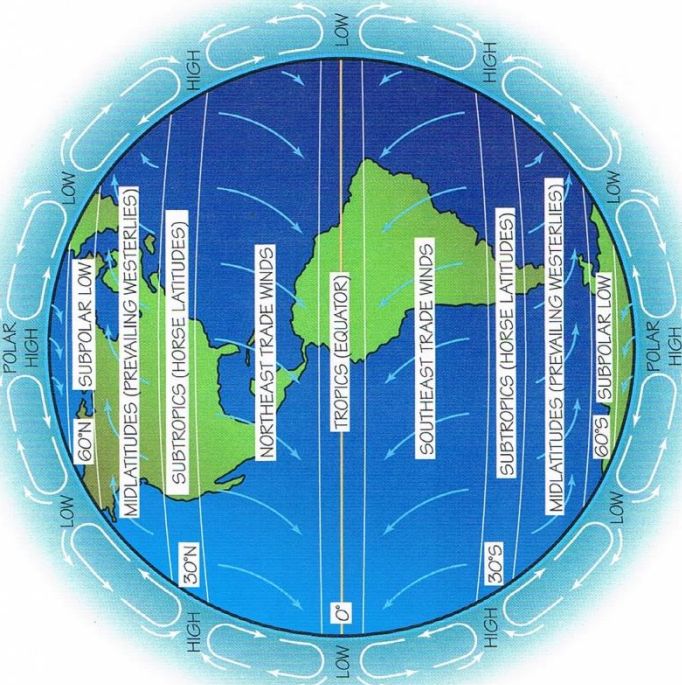

This global winds diagram shows wind's basic patterns. The actual patterns of wind at any given moment are far more complicated.

Notice on the diagram how the surface winds blowing toward the equator in both hemispheres tend to flow from east to west. Similarly, the surface winds blowing poleward tend to include a flow from west to east. Meteorologists refer to winds according to the direction from which they blow. Winds blowing from east to west are called *easterlies*, and winds blowing from west to east are called *westerlies*.

If it were not for the development of easterly and westerly winds, the tendencies for winds to blow straight from high- to low-pressure regions would be very similar to the local breezes described at the beginning of this chapter.

Much of the time, a low-pressure system is related to poor weather, and a high-pressure system is related to fair weather. The rising air of a low-pressure system invites the formation of clouds and precipitation.

The sinking air of a high-pressure system makes cloud formation less likely.

THE CORIOLIS FORCE

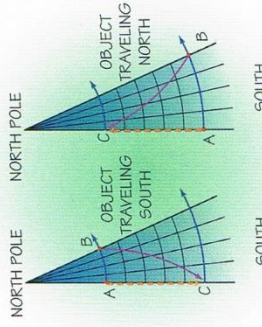

The origin (cannon) moves from A to B due to Earth's rotation. The object (cannonball) follows a curved path (B to C) relative to Earth. From space, an observer would see the object follow a straight line (A to C).

This apparent force—called the *Coriolis force* after French scientist Gustave-Gaspard Coriolis, who first described it—is very real to people living on the rotating Earth. It must be accounted for when firing long-range weapons. It also affects spacecraft such as the space shuttle. For the weather, it makes the moving air seem to curve to the right in the Northern Hemisphere and to the left in the Southern Hemisphere.

Moisture— The Water Cycle

The most important thing about the weather is the moisture it brings. The wind could blow night and day and the temperature could rise and fall, but if no rain fell, Earth would be in real trouble.

Fortunately, in addition to a wonderful air-circulating system, Earth has a wonderful water-circulating system. The water vapor that forms clouds and precipitation comes mostly from *evaporation* from Earth's oceans. A small part comes from lakes, streams, and *transpiration*, that is, the giving off of water by the leaves of green plants.

Most of the rain that falls over land evaporates and is transported as water vapor by the winds, often many thousands of miles from its source. Water vapor *condenses* (changes from a gas to a liquid) in clouds and falls back to Earth as rain, snow, and other forms of *precipitation*. Some precipitation forms *runoff*, the water that flows in rivulets and streams to the rivers. Part of the precipitation filters down into the ground to replenish the *groundwater* supply, which also feeds the rivers. Some groundwater is taken up by plants that restore it to the atmosphere through transpiration.

Some precipitation falls as snow. Of this, most eventually melts and becomes runoff or groundwater. However, part of the snowfall remains frozen, locked into slow-moving rivers of ice called *glaciers*. A considerable amount of Earth's water supply is tied up in the form of ice over the polar regions of the globe, especially in Antarctica. The ice gradually moves in glaciers toward the ocean, but it may take hundreds or thousands of years for water that falls as snow over glaciers to reach the ocean.



A small amount of the groundwater becomes trapped in the ground, forming underground reservoirs called *aquifers*. In many parts of the world, including the United States, the water in aquifers is tapped for human use, especially for irrigation. Once the aquifers are drained, they may not fill again for thousands of years.

Polar ice packs, glaciers, and underground aquifers tie up some of Earth's water supply, but overall, water that evaporates from the oceans eventually finds its way back to the oceans. All of the events described above—evaporation, transpiration, water vapor transport, condensation, precipitation, runoff, and streamflow—are part of a cycle of events known as the *water cycle*, also called the *hydrologic cycle*. On the whole, the cycle is in balance, that is, the total amount of water on the planet remains constant.

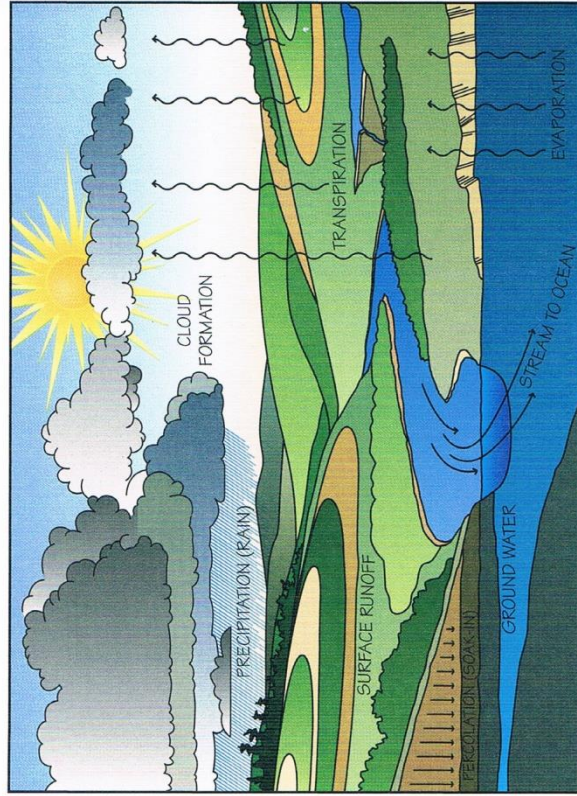

The water cycle

Humidity and Dewpoint

Atmospheric humidity describes the amount of water vapor in the air. Air holding the maximum amount of water vapor possible is said to be saturated. The *saturation point* depends on the air's temperature. Warm air can hold much more moisture than cold air can. Therefore, air can be pushed to saturation when it is cooled or when more water vapor is added (through evaporation or transpiration).

On a clear night, the temperature of the air near the ground may fall until saturation is reached. If the air continues to cool to the point that it can no longer hold all the water vapor, some of the water will be forced to condense onto objects on the ground, forming dew. Under the right conditions, fog can form. Condensation in the atmosphere usually is caused by cooling the air to saturation. Only rarely is condensation in the atmosphere caused by adding water to the air through evaporation at the same temperature.

The *dewpoint* is the air temperature at which saturation takes place when the air pressure stays constant. If the air already is saturated, the air temperature and the dewpoint are the same. Dewpoint often remains fairly constant during the day. A more common measure of atmospheric moisture is *relative humidity*. You probably have heard radio and television announcers give the relative humidity as part of the weather report. Relative humidity is the actual amount of water vapor in the air divided by the maximum amount of water it can hold at that temperature. It usually is expressed as a percentage. For example, saturated air is said to be at 100 percent relative humidity. If the air contains one-half of the total amount of water vapor needed to saturate it, the relative humidity is 50 percent.

However, recall that when the air temperature rises, so does the total amount of water vapor it can hold. Therefore, if the actual amount of water vapor stays the same, the relative humidity decreases when the temperature rises and increases when the temperature falls. That's why relative humidity

Some people refer to dew and frost as precipitation, but they are not forms of precipitation because they do not actually precipitate, or fall.

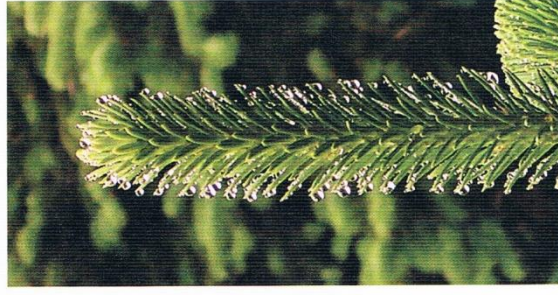

reports can be deceiving. In hot weather, humans sweat to stay cool. As the sweat (water) evaporates from our skin, it takes heat away from the body. If the air is near saturation, sweating is not very effective at cooling us, so we feel uncomfortable.

Human comfort depends more on the dewpoint than on the relative humidity. Summer days can be uncomfortable when the dewpoint rises above 60 degrees, even though the relative humidity at the time of the maximum daytime temperature can be low. Here is an example: At a temperature of 95 degrees and a dewpoint of 65 degrees, the relative humidity is only about 35 percent, but the air will feel hot and muggy. If the dewpoint remains the same and the temperature drops to 70 degrees after dark, the relative humidity will rise to almost 85 percent. Even though the relative humidity is higher, the air will feel more comfortable than it did during the day.

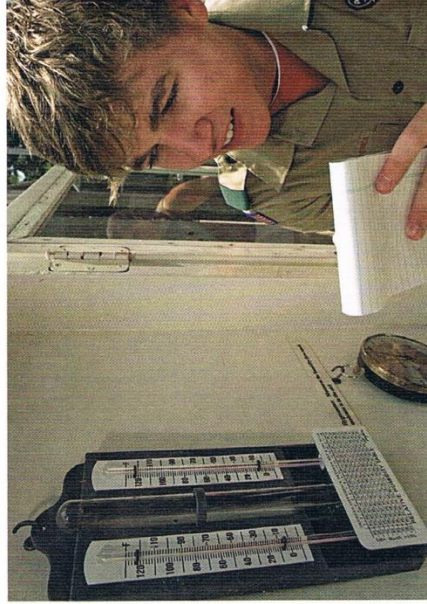

By noting changes in relative humidity as indicated on a hygrometer, you can determine whether the day will be muggy or comfortable.

Condensation: Fog, Dew, Frost, and Rime

Fog is merely a cloud forming at Earth's surface. It forms when warm, moist air comes in contact with the colder air and forms a cloud. The chilled water vapor condenses and attaches to particles in the air.

Fog occurs most frequently at night along water sources where the cooling of slow-moving air, combined with the source of moisture, pushes the air to saturation. Also, when cold air moves over warm water, the water evaporating into the cold air can increase the dewpoint temperature of the air to saturation, resulting in widespread fog. You may have noticed that there is often fog in the mountains and hills. This fog occurs when warmer air moves quickly up a slope. The air cools as it rises, and the water vapor condenses to form fog.



Fog



Dew

Dew is formed when the water vapor in the air condenses on cool objects. Dew usually forms on cool nights during warm seasons. Daytime air that is almost at its saturation point will cool down, and the air will become fully saturated with water. The extra water vapor will condense on objects cooler than the air itself, such as grass and spider webs.

In cold seasons, the same kinds of conditions that bring about dew will form frost instead. Frost occurs when air's dewpoint is below freezing. The condensing water vapor is deposited in feathery patterns of ice crystals instead of tiny droplets. The objects it forms upon must also be below freezing, but the air from which it condenses may be several degrees above freezing.



Frost

When the wind blows fog against objects with surface temperatures below freezing, a type of ice deposit called *rime* forms. The fog particles, which can remain liquid down to temperatures of about -40 degrees, freeze upon contact with the object and build up a white deposit. (A similar deposit may build up in some refrigerator freezers.) The white or milky appearance of rime ice is due to small regions of air that are trapped between the fog particles before they freeze.



Rime

Clouds and Precipitation

Clouds form when water vapor condenses to form ice crystals or water droplets in the air. Cloud formation generally is associated with rising air. Air cools as it ascends because pressure decreases with height. The drop in pressure causes the rising air to expand, eventually, the air to its dewpoint. Then condensation or freezing begins. The water vapor condenses around tiny particles in the air, such as dust or salt from the sea. The resulting droplets are about one-millionth the size of a medium raindrop. These condensed particles are so minuscule that turbulent air motion holds them aloft.

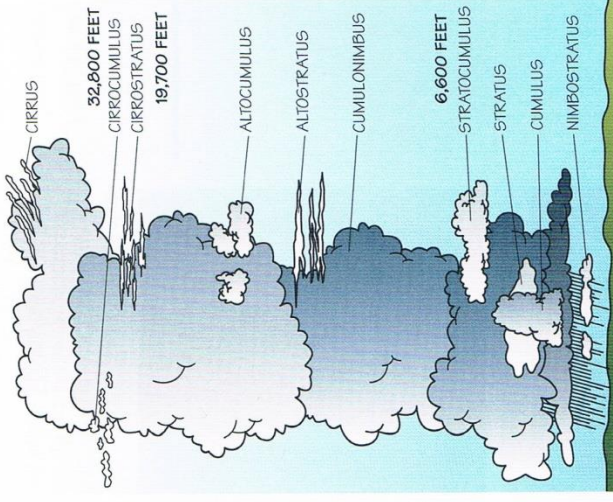

Learning Latin

The cloud names are derived from Latin words. If you learn the Latin meanings, you can more easily remember the cloud types. Here are the basic Latin-based words and their meanings.

Cirrus: Curl or tendrils of hair

Stratus: A layer, like a blanket stretched out

Cumululus: A heap or pile (Think of the word *accumulate*.)

Nimbus: Rain



Cloud Formation and Types

Meteorologists use four main groupings for clouds: low clouds, middle clouds, high clouds, and clouds that develop vertically. Meteorologists also consider the shapes of clouds.

High Clouds

The highest clouds are generally above 20,000 feet and are called *cirrus* clouds. These high clouds are often wispy. *Cirrus* clouds are composed entirely of ice crystals because of their low temperatures and the heights where they form.

Sometimes *cirrus* clouds are lumpy. Those are called *cirrocumulus*. *Cirrocumulus* clouds can be arranged in patches or aligned in rows.



Cirrus clouds

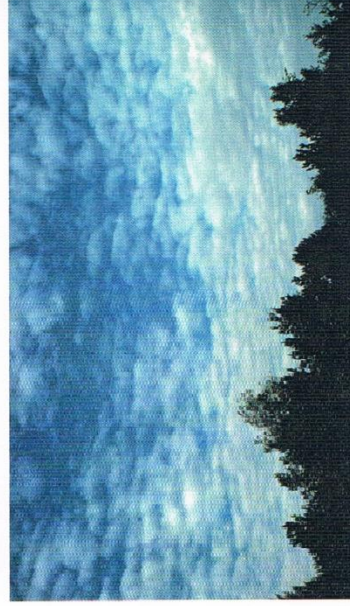

Cirrocumulus clouds

Cirrus clouds are sometimes called "mare's tails" because they look a bit like a horse's tail.

Cirrus clouds forming in extensive flat layers are known as *cirrostratus*. *Cirrostratus* clouds can cover the whole sky or only part of it and can be quite thin and nearly transparent. When *cirrus* clouds give way to *cirrostratus*, precipitation may be on the way within the next 24 hours.

The deep, towering thunderheads known as *cumulonimbus* clouds can be more than 50,000 feet tall and can occupy more than one height category. Their height certainly qualifies them to be high clouds, though meteorologists think of them as clouds of vertical development. *Cumulonimbus* clouds almost always flatten out near the tropopause. Their flat, anvil-shaped top is a help in identifying them. *Cumulonimbus* clouds will likely bring lightning, heavy rain, and possibly hail.

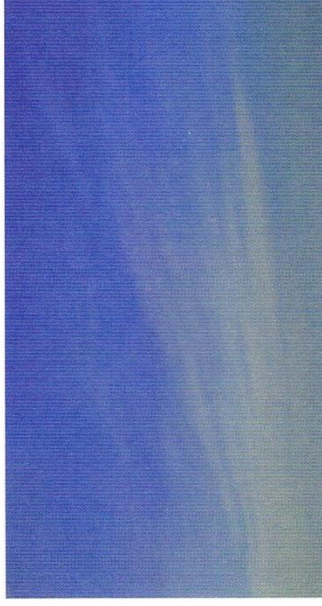

Cirrostratus clouds



Cumulonimbus clouds



Altocumulus clouds



Altostratus clouds

Fog can be thought of as a stratus cloud at the surface.

Low Clouds

Low clouds appear from near Earth's surface up to about 10,000 feet. *Stratus* clouds appear as a uniform cloud layer, with little or no texture.

Stratocumulus clouds typically are flat and nearly uniform at their bases but puffy and clumped on top. They are likely to form heavy ridges that look like corrugated roofing. Stratocumulus clouds often indicate heavy precipitation, especially if they are at the head of a cold front.

Nimbostratus clouds are dark, sheetlike clouds and indicate that rain or snow is falling.

Cumulus clouds form below 6,500 feet but can grow very tall, much taller than they are wide. Meteorologists consider them clouds of vertical development. When these fluffy "cloud ships" float in the bright blue sky, they are called fair-weather cumulus, and they usually mean good weather is ahead.



Stratus clouds

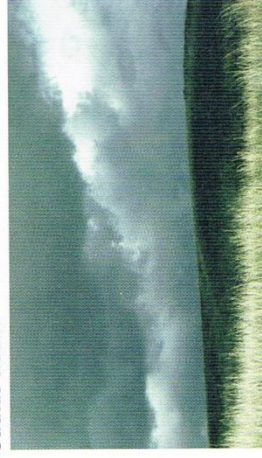

Nimbostratus clouds



Cumulus clouds

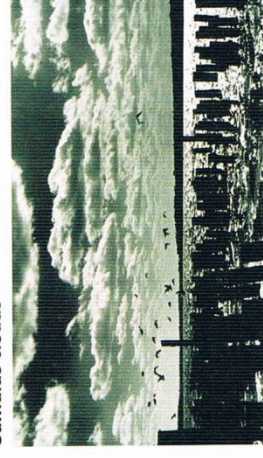

Stratocumulus clouds

Precipitation

A cloud is made of water vapor that has condensed into tiny water droplets or ice crystals. As more and more water vapor condenses, some of the particles collide with each other and merge to form droplets large enough to begin to fall. As they fall, they continue to grow by sweeping up smaller droplets along the way—a process called *coalescence*. When droplets become just large enough to fall to the surface, they are called drizzle. It may take a thousand or more cloud droplets to form a single drop of drizzle. As the droplets continue to grow, they reach a size large enough to be called rain.

Snow forms when cloud temperatures are well below freezing. Ice crystals become larger when they attract water from nearby supercooled water droplets. When the ice crystals are heavy enough to fall, they stick to other ice crystals and form snowflakes. Snow can form and fall even when temperatures at Earth's surface are above freezing. If surface temperatures are warm enough, however, the falling snow will melt before reaching the ground and will fall as drizzle or rain.

Melting snowflakes usually are small enough to become drizzle, but sometimes snowflakes clump together and form small white pellets called *graupel* (pronounce the “au” like “aw” in “crawl”).

Most of the time, raindrops are not collections of smaller water droplets but are instead melted snow or graupel. If the air never becomes very warm, as in the winter, the snowflakes and graupel simply fall as snow and snow pellets.

Sometimes rain will fall and hit a layer of below-freezing air before it reaches the ground. The rain then forms ice pellets, or *sleet*. If rain falls to the ground and hits a very cold surface, the result is *freezing rain*. Freezing rain can cause icy road conditions and can form heavy ice coverings on power lines and vegetation.

One of the most spectacular forms of precipitation is *hail*. Hail is the result of ice forming in the rising currents of air, or *updrafts*, of thunderstorms. When an updraft is strong enough, it holds the ice aloft. Many layers of supercooled water freeze to the ice pellets, adding to their size. They give the hailstone a structure like an onion.

The Dirt About

Snowflakes

Dirt, pollen, sand, dust—these are the kinds of elements that serve as building blocks for ice crystals, which

join together

to become

snowflakes. Each

delicate snowflake

has six sides

and is made up

of as many as

200 ice crystals

stuck together.

The hailstone grows until the updraft can no longer hold it aloft or until its motion within the storm carries it out of the updraft. Then it falls to the ground, perhaps melting somewhat as it nears the surface. Hailstones can range from the size of small peas to the size of grapefruits. Large hailstones often are not simple spheres, but take on irregular shapes as a result of being tossed and turned within the turbulent air of the thunderstorm.



Hailstone

Supercooling

An interesting phenomenon called *supercooling* plays a role in the formation of snow. Water that is supercooled remains in its liquid state when the temperature is below freezing. The reason the water does not freeze is that, in order for a liquid to crystallize into a solid, there needs to be something for the crystals to form around, such as a particle of dust, salt, or plant matter. If a water droplet in a cloud contains no such particle, or nucleus, it will remain liquid. However, when a nucleus is present, an ice crystal will begin to form and grow around the nucleus.

Visibility

Visibility indicates the transparency of air. Air contains particles that reflect and scatter light, so that objects at a distance cannot be seen. Smoke from fires, dust picked up over land, and salt particles from evaporated ocean spray can be carried great distances by wind and can collect in still areas. Water droplets in the form of clouds or fog can also reduce visibility, as can raindrops and snowflakes if there are enough of them.

To determine visibility for meteorological purposes, look for several objects whose distances from the observing point are known. By noting the distance of the farthest object that can be seen, you can then estimate visibility. Visibility is normally reported in miles or a fraction of a mile. Visibility is essential in aircraft operation and in navigating almost any kind of transportation vehicle (cars, trucks, and especially planes and boats). Observations of visibility are routinely reported all over the world.

Watching the Sky

The movement of a frontal system often is heralded by a procession of different cloud types, each signaling a greater likelihood of an approaching storm. You might first see a clear sky of high, feathery cirrus clouds, or "mare's tails." These clouds will thicken until the sun is hidden behind a thin cirrostratus veil. A gray curtain of altostratus clouds comes next, followed by a moist blanket of dark stratus clouds rolling close to Earth. Finally, nimbostratus clouds bring rain.

Of course, not all clouds signal bad weather. Cirrus clouds detached from one another indicate that the weather will stay fair for a while. A scaly mackerel sky formed by cirrocumulus clouds usually promises fair weather, but it also might be a sign of inclement weather. Outdoor groups eager for dry trails welcome the sight of cumulus clouds. On hot days, however, travelers are wise to take cover if swelling cumulus clouds develop into dark cumulonimbus thunderheads, the breeders of violent storms.

Fronts

In radio and television weather reports, you often hear about fronts. A weather reporter might say something like, "A warm front is coming up the coast" or "A strong cold front is moving down from Canada." These reports sound as though an invasion were on the way! In a sense, that's right. The reports are describing the invasion of air masses.

Air masses form when air remains in place over a particular region for several days. The air gradually takes on the characteristics of the surface beneath it. For example, air over tropical oceans becomes warm and moist, while air over snow-covered polar regions becomes dry and cold. When the air moves away from the place where it formed, known as its *source region*, it replaces air of a different type. The boundaries between air masses of different types are what meteorologists call *fronts*. Fronts are regions of transition, and often are where important weather events take place.

Air masses usually are associated with high-pressure regions (anticyclones) at the surface. Low-pressure regions (cyclones) dominate on the boundaries of air masses. By increasing the winds and pushing the air away from its source, the development of cyclones causes air masses to move away from their source regions.

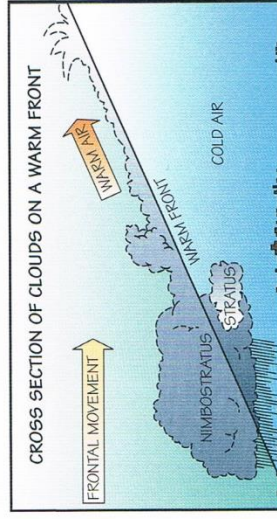
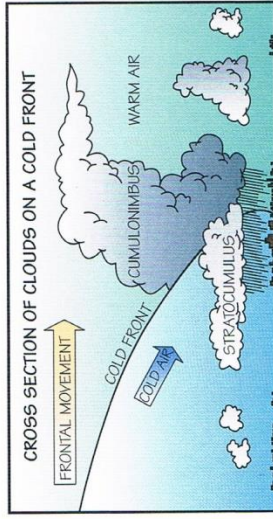

When cold air replaces warmer air, the front is called a *cold front*. In the United States, cold air usually comes from the north or northwest of Canada and from the polar regions. Because cold air is denser than warm air, it tends to stay nearer the surface and wedges beneath the warm air. This tends to make the warm air rise, as seen in the diagram. The rising air cools by expansion, forming clouds and perhaps precipitation.

Because the advancing cold air remains near the surface where friction is a factor, the movement of the cold air is slowed somewhat by the friction of objects and landforms on Earth's surface. This creates a steep slope along the leading edge of the front. The slope can mean that most of the rising motion along the front is confined to a narrow zone near the front.

When warm air replaces cold air, the front is called a *warm front*. Warm air masses form over the warm tropical oceans south and southeast of the United States and over land areas to the southwest. Those forming over oceans are moist. Those forming over land are dry. When warm air approaches a cold air mass, it tends to ride up over it rather than wedging beneath it. Unlike cold fronts, therefore, warm fronts tend to have gentle slopes. As the warm air rises and cools, clouds and precipitation may form. The shallow slope means that rain and clouds can precede the passage of a warm front by a day or more.

Hazardous Weather

People readily adapt to routine weather changes that occur with the passage of air masses. Sometimes, however, the weather can become so violent that people need to take special precautions.

Forecasters with the National Weather Service issue watches, warnings, and advisories to alert the public to potentially violent or hazardous weather. There is an important difference between a watch and a warning. A *watch* means that hazardous weather is possible or that conditions are favorable for it to develop.

A *warning* is a more urgent notice that hazardous conditions already exist or are heading your way. Watches and warnings are issued for events such as winter storms, tornadoes, severe thunderstorms, high winds, and flash floods. The National Weather Service issues *advisories* when conditions are expected to cause serious inconveniences. A common type of advisory alerts motorists to hazards such as slippery roads caused by wintry weather.

Winter Storms

During the winter, some *cyclones* (low-pressure areas) develop into unusually intense storms that bring heavy snow, strong winds, and cold temperatures. When the wind is strong enough (above 35 miles per hour) and visibility is reduced to less than a quarter mile by snow or blowing snow, the event is termed a *blizzard*. Even if a snowstorm does not quite qualify as a blizzard, a combination of snow, wind, and cold can be deadly for people caught unprepared.

Another winter event that can be quite severe is freezing rain (or drizzle), or an *ice storm*. If ice coatings build up enough, tree branches can break, often crashing into power and telephone lines already burdened with ice. Roads become ice-covered and treacherous.

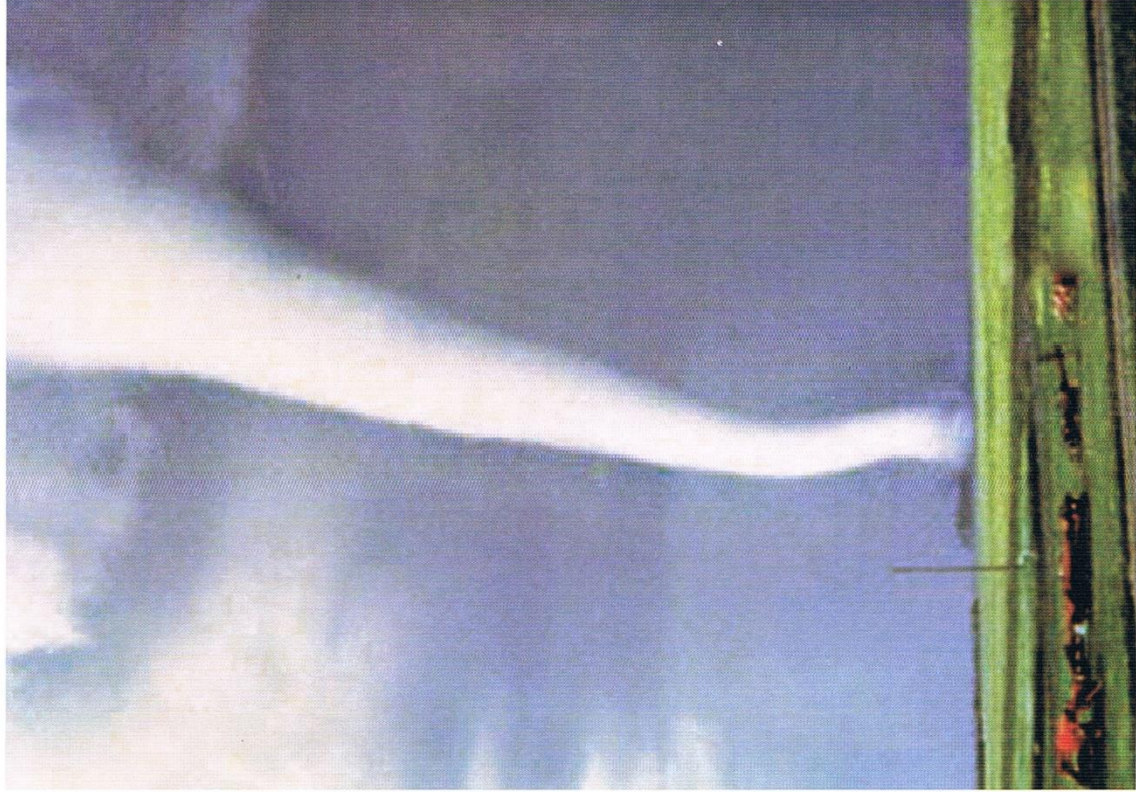

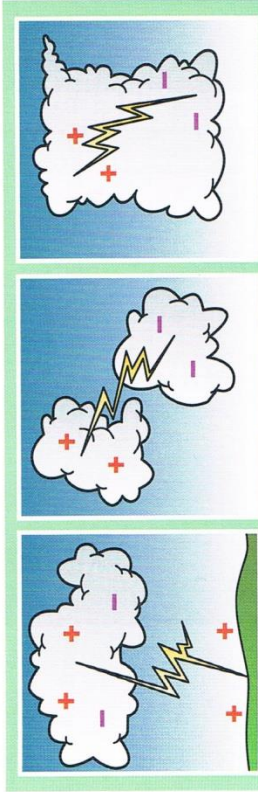

The instability of electrical charges within a cloud is heightened by collisions of ice crystals and hail and by differences in air temperature at different altitudes. When the imbalance becomes great enough between negatively charged and positively charged areas of clouds or between a cloud and the ground, electrons (negatively charged subatomic particles) form a pathway called a leader and flood from one zone to the other, resulting in a lightning strike.

Thunderstorms

Thunderstorms are most common in the tropics and subtropics and during the warm season in the middle latitudes, but they can occur in winter and at polar latitudes. They form when warm, moist air creates updrafts that form large precipitation drops in clouds. As this precipitation develops, positive and negative electrical charges separate and build up in different parts of the clouds and on the ground beneath the clouds. When charges have built up enough, they can “jump the gap” between regions of opposite charge, discharging the areas.

This discharge is what we see as *lightning*. Some lightning flashes strike the ground, but most are from one part of a cloud to another. Lightning ground strikes, fairly common in the United States, can be deadly. In the United States about 90 people die each year from being struck by lightning.

Thunder is caused by the great heat generated during the brief time (less than a second) that a lightning discharge occurs. The heat causes the air to expand rapidly, as in an explosion.

You hear thunder *after* you see lightning because of the difference between the speed of sound and the speed of light. Sound travels at a speed of 1,100 feet per second, but light travels at a speed of about 186,000 miles per second. Therefore, you will see a lightning flash almost instantly, but the sound of thunder will take longer to reach you.

Staying Safe During a Thunderstorm

If you are caught outdoors in a thunderstorm, do not stand in open areas or near lightning targets such as trees, power poles, or wire fences. Metal conducts electricity, so also stay away from metal poles (such as tent poles) and such. Remove any metallic frame packs and do not stay near them.

Water also conducts electricity, so if you are boating or swimming, get to land immediately when a storm is approaching.

When hiking near mountaintops, which are struck by lightning often during summer, get downhill before the lightning begins, if possible. If a storm catches you, take shelter in a cave or a low spot among the rocks, making sure to avoid prominent outcroppings and overhangs. Try to pick an area that is not likely to flood.

If you cannot find shelter, become the smallest target you can. Do not lie flat on the ground, because lying flat makes you a bigger target than crouching down. If you feel your hair stand on end or your skin get tingly, crouch down immediately and take the following pose: Squat on the balls of your feet, cover your ears with your hands, and get your head close to your knees. Get small! The less of you that is touching the ground, the better.

Take shelter in a steel-framed building or hard-topped motor vehicle (not a convertible) if you can. Such places are safe because the charge stays within the frame of the building or vehicle and is conducted safely to ground without endangering the occupants. When you are taking shelter in a car during a thunderstorm, avoid touching the metal parts.

When taking shelter in a building during a thunderstorm, do not use the telephone or hold objects connected to electrical power (such as hair dryers). Staying near stoves, fireplaces, and plumbing is also dangerous, because metal can conduct electricity. Also, do not take a bath or shower or run water.

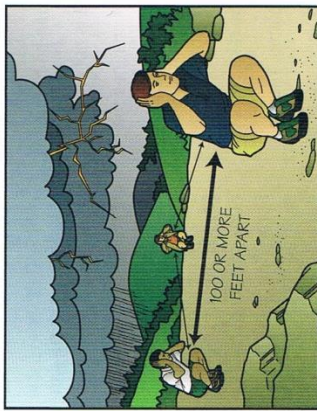

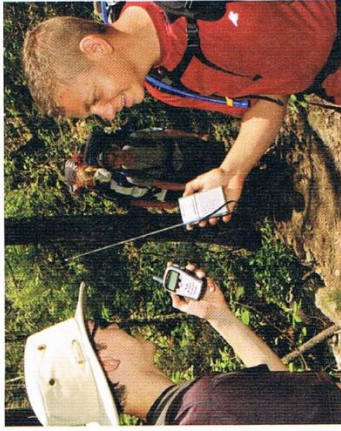

Although the location where lightning will strike is not predictable, some places are much more likely to be struck than others.

Because lightning follows the path of least resistance, objects closer to the cloud are more likely to be struck. Trees in an otherwise open space often are targets for lightning, so trees are not a good place to take shelter in a thunderstorm.

Thunderstorms can become quite violent, producing large hail, flooding rains, strong winds, and tornadoes. These severe thunderstorms tend to occur where the air mass is very unstable. During winter, a single cyclone can produce blizzards, ice storms, and severe thunderstorms with tornadoes.

When taking safety precautions during a thunderstorm, you should stay alert and be ready to revise your plans if a more hazardous weather condition occurs, such as a flash flood.

Floods

Floods are an unavoidable part of life along rivers. The torrential rains of thunderstorms or tropical cyclones can cause flooding. Some floods occur when winter or spring rains combine with melting snows to fill river basins with too much water too quickly. Such events usually take several days to develop. Other floods arise suddenly as the result of heavy localized rainfall. These *flash floods* can become raging torrents very fast, sometimes in less than an hour, and can sweep away everything in their path.

Areas of rugged terrain are particularly vulnerable to flash floods. Picturesque river valleys in the mountains can be swept without warning by floods from rains falling some distance away. When camping, stay clear of natural streambeds during the time of year when rainstorms are common. If you camp on low ground, you might be caught unawares, especially when asleep at night. In case of a flood in rugged terrain, climb to high ground immediately, even if it means abandoning your gear. If the floodwaters are already rising, do not get into motor vehicles and attempt to drive away from the flood danger. Never enter a flooded low spot on the road or trail if you do not know how deep the water is, especially if the water is rising.

Although lightning can be hazardous, it is not all bad. It changes the air's nitrogen into a form that can be taken up by plants. Thus, a thunderstorm can be a natural plant fertilizer as well as a waterer.

Most fatalities of floods are victims trapped in automobiles. It takes only 2 feet of water to float a car, and even less to stall a car or truck's engine. If your vehicle's engine stalls, abandon it and climb to higher ground.

Keep alert to signs of wet weather—not just in your location but also in nearby areas. Listen for distant thunder and watch for lightning flashes. Faster flowing streams or rising water levels can signal rainfall upstream. In seasons when heavy rains are possible, at least one person in your group should carry a portable radio and stay informed about weather conditions when in range of a radio station. When out of radio range, be keenly observant and alert to the weather.

Tornadoes

On rare occasions, rapidly rotating columns of air form within a thunderstorm. When these rotating columns reach Earth's surface, they become *tornadoes*.

Tornadoes can produce the strongest winds on Earth, occasionally reaching 300 miles per hour or more. The tornado is an extreme form of cyclone, with very low pressure at its core. Most tornadoes produce paths of damage that are only a few hundred yards wide or less. Because tornadoes usually last only a few minutes, path lengths typically are a mile or less. A few tornadoes, however, are more than a mile wide and last for an hour or more, producing damage paths more than 100 miles long.

Most tornado casualties are caused by flying debris, so the best thing to do if a tornado threatens is to get to a place that provides as much protection from flying debris as possible. Avoid taking shelter near trees. They become a source of debris during tornadoes. If you are caught in the open when a tornado approaches, get to a low spot, lie face down, and cover your head. Your goal is to be less of a target for flying debris. Therefore, lying flat is the right position. A ditch or other low spot is a good place to lie down, especially if there is no flood water.

Tornadoes can occur while you are in school or at home. Be aware of any plans for tornado safety in your school. You and your family should develop a safety plan at home. If your home has a tornado shelter, use it. If your home has a basement, it can be a good shelter if part of it offers protection from falling debris. For example, you might take shelter under a stairway or a heavy workbench.

As with floods, never attempt to drive away from a tornado. You are likely to be trapped in your vehicle, which is an extremely dangerous situation.

If you cannot get to a tornado shelter or basement, put as many solid walls between you and the outside as possible. Closets in interior hallways are good shelters. Bathrooms often have stronger walls than the rest of the house because the plumbing makes a kind of reinforcement. Stay away from windows—flying glass is extremely hazardous. Abandon mobile homes and seek nearby shelter. Take along a radio and some source of fresh water. If your home is hit, be alert to leaking gas from broken pipes. Outside, beware of fallen power lines.

Hurricanes

Among the most dangerous storms that affect the United States are *turricazes*. They originate in the southern part of the north Atlantic Ocean, the Caribbean Sea, the Gulf of Mexico, and the southeastern Pacific Ocean off the west coast of Mexico. Similar storms occur elsewhere in the world, notably in the oceans near India and Australia, where they are called *cyclones*, and in the western Pacific Ocean, where they are called *typhoons*. A general name for all such storms is *tropical cyclone*.

Unlike the low-pressure systems of middle latitudes, tropical cyclones contain no fronts because they form in a single, tropical air mass. When well-developed, they are nearly circular in shape and vary in diameter from about 100 to 1,000 miles. In rare instances, their winds can exceed 200 miles per hour, spiraling inward to the low-pressure center. The combined effects of the winds and the low pressure act to pile up ocean water at the center of the storm, producing a *storm surge*. As the storm approaches land, the storm surge can combine with normal tides to produce extensive flooding. It is the storm

surge, not the wind, that causes the most damage and the most casualties from hurricanes. Most hurricane deaths are caused by drowning.

At the center is the *eye* of the storm, which can range from about 5 miles to more than 20 miles in diameter. Within the eye, winds are light. Low clouds might be present, or skies might actually be clear

within the eye. Surrounding the eye is a ring of deep clouds called the *eyewall*. The strongest winds in the storm usually are found within the eyewall next to the relatively calm eye. Several cloud bands made up of lines of thunderstorms, called *spiral bands*, usually are present in a tropical cyclone. They spiral into and join the eyewall from the outer parts of the storm. Torrential rains often accompany the eyewall and the spiral bands.

Tropical cyclones “feed” on warm tropical ocean waters. This is how they obtain their strength over the open waters of the tropics and why they normally weaken rapidly and soon dissipate after they meet land. But even a dissipated hurricane can produce extremely heavy rainfall—sometimes well inland from the point where it made landfall.

Most hurricanes produce occasional tornadoes from the thunderstorms in the spiral bands.

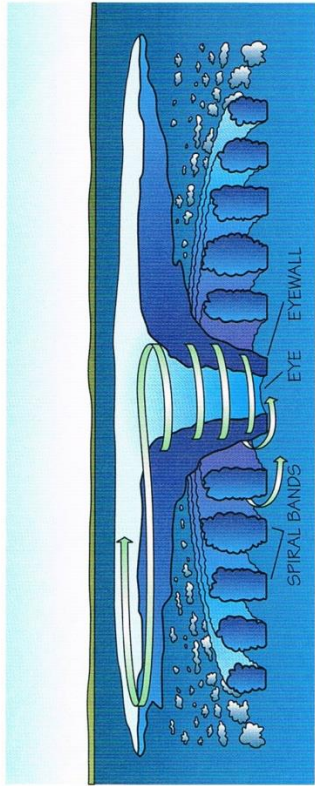

Cross section showing the structure of a typical mature tropical cyclone

In nearly all cases, hurricane watches and warnings will precede any landfalling hurricane. If you are camping along or near a seashore when hurricane watches are issued, strike camp and leave the area immediately. Encountering a hurricane at sea also is extremely dangerous and should be avoided at all times.

If officials have not advised that you evacuate the area, stay indoors, away from windows, and follow the guidelines for tornado safety. After the eye passes, the hurricane winds blow in the opposite direction, breaking trees and other things not quite destroyed by the first round of winds. Do not be fooled by the eye of the storm. Much danger still follows. Follow safety procedures for floods as well.

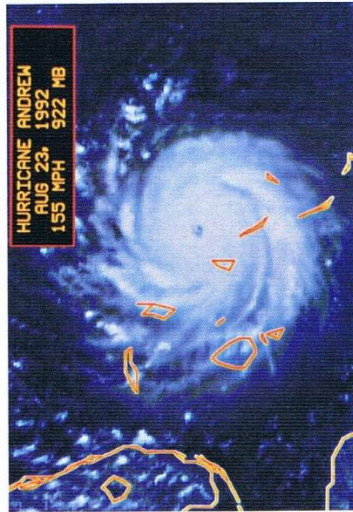
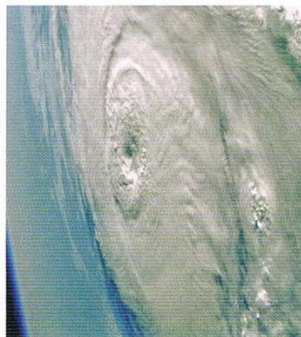

Measuring and Recording the Weather

Accurate information about the various factors that together define the weather is necessary in making reliable forecasts. For each of these factors, there is an instrument that measures intensity, velocity, or degree.

Air Pressure

Air pressure is measured using a *barometer*. An *aneroid barometer* is the type you are most likely to have at home or see in stores. It uses a small, thin-metal "box" sealed with average air pressure inside. The box contracts under high pressure and expands when the outside air pressure drops. An indicator needle is attached to the side of the box by levers and records the pressure on a dial.

Scientific barometers used by laboratories and weather offices contain mercury, a metallic element that is liquid at room temperature. A simple *mercury barometer* consists of a slender glass tube filled with mercury and closed at one end. The open end of the tube rests in a bowl of mercury. The mercury in the tube falls to a level that is about 30 inches above the level of that in the bowl. A vacuum forms at the top of the tube. Air pressure acts on the surface of the mercury in the bowl, forcing the mercury up into the tube. The higher the air pressure, the higher the level of mercury in the tube.

Mercury is very poisonous. Just a small amount can pollute a large body of water such as a lake. The United States government has placed restrictions on mercury. If you have an old barometer that uses mercury, be careful never to open it up. Liquid mercury can be absorbed through your skin. Just a small amount can also poison the air, and disposing of it improperly will cause pollution.



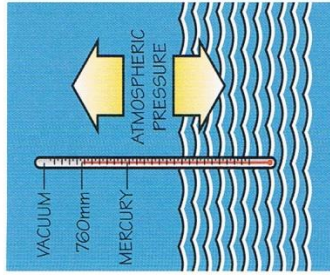

Downward air pressure on the mercury in a mercury barometer forces mercury up into the tube. The higher the air pressure, the higher the mercury column.

Barometers, either mercury or aneroid, are read in terms of the height in inches of a column of mercury. Average air pressure at sea level corresponds to a column of mercury about 30 inches tall. This is where the barometer reading comes from on weather reports—a pressure of 30.25 inches, for example. Air pressure at sea level varies by only a small amount. A reading of, say, 31 inches is unusually high, while a reading below 29 inches occurs only in the strongest cyclones, such as hurricanes.

The exact height of the mercury column depends not only on air pressure, but also on the altitude where the reading is taken. To adjust for differences in elevation, it is common to correct the readings for altitude so that the measurements are comparable to those taken at sea level.

On actual weather maps, pressures are converted to *millibars*, the scientific unit used to measure pressure. The numbers on the isobars on a weather map correspond to pressure adjusted to sea level in millibars.

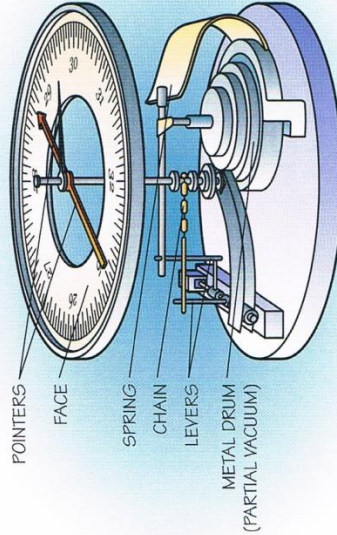

Changes in pressure result in changes in width of an aneroid barometer's sealed box. Levers and springs convert these changes into pressure readings.

The rate at which the air pressure is changing often is more important than the pressure reading itself. Air pressure rises typically with the approach of high pressure and its attendant fair weather. So if you hear a weather reporter say, "The barometric pressure is 29.65 inches and rising," you can be pretty sure that good weather is on the way. Likewise, the approach of a low-pressure area causes the reading to fall.

Wind Direction

You probably have seen *wind vanes* on houses and barns. Most are in the form of an arrow that pivots on special bearings so that it can turn freely in the wind. It is accurately balanced on the bearing. The size of the "feather" part of the arrow is larger so that wind vanes always swing into the wind and point in the direction from which the wind is coming.

Wind Speed

Wind speed is measured by an instrument called an *anemometer*. Although there are several types of anemometers, the most common type is a cup anemometer, in which three or four cups are mounted on horizontal rods. The unit is attached to a vertical rod so that it can rotate as the wind turns it. As wind speed increases, so does the speed at which the cups rotate. Wind speed is measured by the number of turns the cups make in a set period of time.

Wind speeds can be measured in miles per hour, in knots, or in meters per second. A knot is one *nautical mile* per hour—a nautical mile is about 6,080 feet, roughly 15 percent longer than an ordinary mile of 5,280 feet. Miles per hour normally are used in the weather reports you hear on radio and television, while knots are used mostly in marine and aviation weather reports. Most scientific measurements are in meters per second.

A professional wind vane usually has electrical connections to a scale in the weather office so that no one has to go outside to read it. Weather reporters do know enough to stay out of the rain!

Beaufort Number	Description	Wind Speed (mph)	Observations (visible effects on land)
0	Calm	Less than 1	Smoke rises vertically.
1	Light air	1-3	Wind direction is shown by smoke drift, but not by wind vanes.
2	Light breeze	4-7	Wind is felt on the face; leaves rustle; ordinary vanes are moved by the wind.
3	Gentle breeze	8-12	Leaves and small twigs are in constant motion; wind extends a light flag.
4	Moderate breeze	13-18	Dust and loose paper are raised; small branches are moved.
5	Fresh breeze	19-24	Small trees in leaf begin to sway; crested wavelets form on inland water.
6	Strong breeze	25-31	Large branches are in motion; whistling is heard in telegraph wires; an umbrella is difficult to use.
7	Moderate gale	32-38	Whole trees are in motion; inconvenience is felt in walking against the wind.
8	Fresh gale	39-46	Twigs break off trees; progress generally is impeded.
9	Strong gale	47-54	Slight structural damage is reported; branches break.
10	Whole gale	55-63	Considerable structural damage is reported; trees are uprooted; seldom experienced inland.
11	Storm	64-72	Widespread damage is reported; very rarely experienced.
12	Hurricane	Above 72	Extreme damage is reported.

This scale was devised by Sir Francis Beaufort in 1805. Although used mainly to estimate winds at sea, the visible effects described here relate to observations on land.



Make a Wind Vane

Materials Needed

- Aluminum baking dish, pie tin, or tray
- Sturdy wooden garden stake (at least 3 feet tall and 1 inch thick)
- 12-inch piece of wood about ½ inch thick
- Nail (2 to 3 inches long)
- Electric or hand drill
- Thick metal washer
- Hammer
- Mallet
- Glue
- Small saw
- Scissors

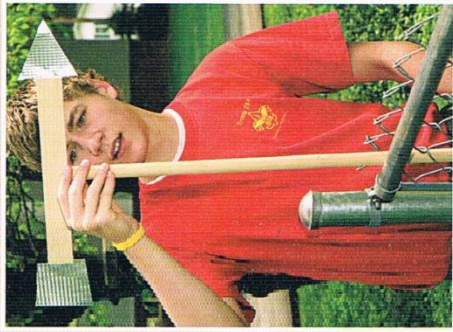

Step 1—Select a location for your wind vane. Then use the mallet to carefully drive the garden stake into the ground.

Step 2—Use the saw to cut a half-inch slot at each end of the 12-inch piece of wood.

Step 3—With an adult helping you, place the piece of wood on top of the stake, as shown, and drill through the wood and the stake. Use a drill bit that is slightly larger in diameter than the nail you will be using.

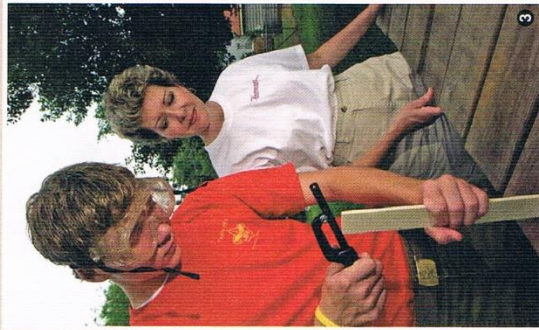

Step 4—Place the washer on top of the stake and insert the nail through the wood and into the stake. The wood should turn easily on the axis of the nail.



Step 5—Cut the head and tail of the arrow from the aluminum tray or dish using the pattern shown as a guide. Glue the head of the arrow into one slot in the piece of wood and the tail into the other slot.

Air Temperature

Air temperature is an important factor in weather, especially when associated with other factors such as humidity and pressure. It is measured with a *thermometer*.

The most accurate thermometers are the liquid-in-glass-tube type, containing either mercury or alcohol. The alcohol version is more appropriate for very cold places because alcohol freezes at a lower temperature than mercury.

A thermometer should be kept in the shade and away from wind and rain. The weather professional's thermometer is housed in a ventilated box raised above the ground and protected from the weather.

For most of the United States, -40 degrees Fahrenheit to 110 degrees Fahrenheit is a range of temperatures wide enough to cover most temperature observations. In Death Valley, California, however, the temperature once soared to 134 degrees, while in Yellowstone National Park the temperature has been known to plummet to -66 degrees. In such places, you need a special thermometer.

Make a Cup Anemometer

Materials Needed

- New sharpened pencil
- 5 plastic foam cups
- Hole punch
- Straight pin
- 2 extra long plastic straws
- Felt marker
- Tape

Step 1—Mark the numeral “1” on one of the cups and set it aside.

Step 2—Set one of the unmarked cups on a work surface and punch four holes in it as shown. Be sure one set of holes is lower than the other set of holes.

Step 3—Carefully poke the pencil through the bottom of the cup.

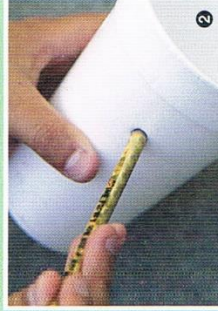

2



3



4

Step 4—Push the pencil down so that it is below the holes and then thread the straws through the holes in the top of the cup to make a cross shape. Tape the straws in place.

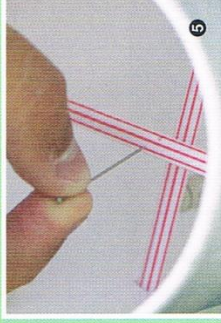

5

Step 5—Raise the pencil up so that the eraser comes into contact with the crossed straws. Push the straight pin through the straws and into the eraser. Do not push the pin all the way in. The unit needs to be able to turn freely.

Step 6—Punch one hole each in the side of the other three unmarked cups and the marked cup, and mount them on the straw apparatus as shown. If necessary, add tape to better secure the cups to the straws.

Step 7—To determine wind speed, count how many complete revolutions the marked cup makes in one minute.

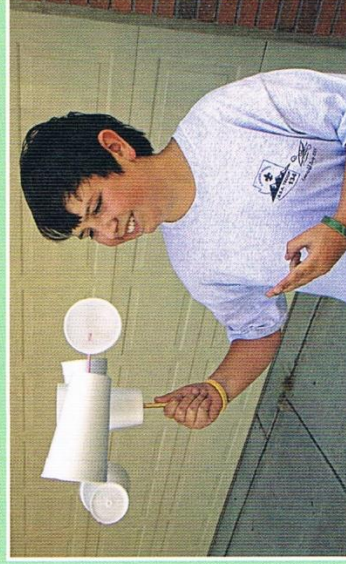

In most of the world, temperatures are measured in degrees Celsius, but in the United States surface air temperatures are measured and reported in degrees Fahrenheit. Water freezes at 32 degrees Fahrenheit, which is 0 degrees Celsius, and boils at 212 degrees Fahrenheit, or 100 degrees Celsius.

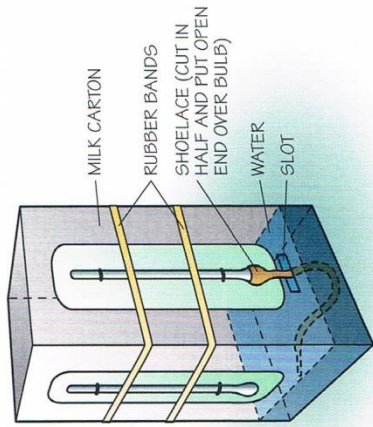

Wet-bulb hygrometer

Water Vapor

A common instrument for finding out the amount of water vapor in the air is the *wet-bulb hygrometer*. It is relatively easy to make. Begin by purchasing two identical liquid-in-glass alcohol thermometers. These can be bought in hardware stores for a reasonable price. Mount both thermometers on a milk carton exactly the same distance from the bottom. Cut off about 6 inches of a new, round shoelace, trimming off the tip. Slip the shoelace over the bulb portion of one of the two thermometers. Cut a slot in the milk carton so that you can slip the bottom part of the lace into the carton. Fill the carton with water up to the slot. If possible, use distilled or filtered water because impurities in the water will cause inaccurate readings.

Place the carton in the breeze of an electric fan or in a breezy open window. Make sure the shoelace is wet up to the thermometer bulb. Evaporation of water from the lace will cause the temperature measured by the wet-bulb thermometer to decrease, while the other thermometer should remain at the actual air temperature.

Using the following chart, you can figure out the relative humidity by the temperature difference between the two thermometers. When they both read the same, or nearly so, expect wet weather because that means high (nearly 100 percent) relative humidity. Generally, the wet-bulb temperature is somewhere between the actual air temperature and the dewpoint temperature.

Relative Humidity Based on Dry-Bulb (Air) and Wet-Bulb Temperatures

Difference (dry-bulb minus wet bulb)	Dry-bulb temperature (Fahrenheit)									
	30	40	50	60	70	80	90	100		
1	88	92	93	94	95	96	96	—		
2	77	84	87	89	90	92	92	—		
3	67	76	80	84	86	87	89	—		
4	57	68	74	78	81	83	85	—		
6	37	53	62	68	72	76	78	80		
8	17	38	50	58	64	68	71	74		
10		23	39	49	56	61	65	68		
12		9	28	40	48	54	59	62		
14			17	31	41	48	53	57		
16			7	23	34	41	47	52		
18				14	27	35	42	47		
20				7	20	30	37	42		
22					14	24	32	38		
24					7	19	27	33		
26					1	14	22	29		
28						9	18	25		
30						4	14	21		

Using this table, compare readings on a wet-bulb thermometer with those on a dry-bulb thermometer to determine relative humidity. Check the degree difference shown on your two thermometers. Find this number in the left column of the table and read across to the column under the air (dry-bulb) temperature. The value shown is the relative humidity. Example: If the difference between dry- and wet-bulb temperature is 6 degrees and the air temperature is 70 degrees, the relative humidity is 72 percent.

Rainfall

Rain is measured with a *rain gauge*. We measure rain in terms of the depth of the layer it would make if none drained off or was otherwise lost. In the United States, rainfall is measured in inches to the nearest hundredth. An amount too small to measure is called a *trace*.

Rainfall can be measured in many ways, but usually a large funnel and narrow receptacle are used. The figure shows a simple type of rain gauge that you can make.

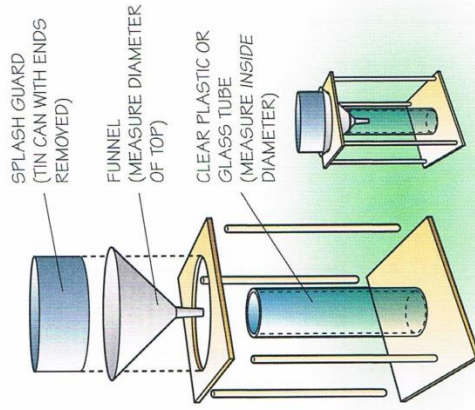

Rainwater funnels into a narrow tube so that amounts can be read more accurately. Measure the diameters of the funnel top and the tube and calculate their ratio. Mark off the tube, then square that ratio. For example, if the funnel opening is twice as wide as the tube, then 4 inches (2 times 2) in the tube will mean 1 inch of rainfall. If the ratio is 3 to 1, then 9 inches (3 times 3) will equal 1 inch of rain, and so forth.



Weather Maps

The various elements just described, including temperature, pressure, wind, and precipitation, are measured at weather stations all over the world at specified times each day. Observations usually are made every six hours at all land stations and aboard ships at sea.

Weather observations are prepared using a short code of numbers and are transmitted electronically to major weather centers. The contents of these reports are plotted on surface weather maps, mostly by computers. In addition to the surface reports, information is gathered by balloon-borne instruments called *radiosondes*. A radiosonde consists of instruments that measure temperature, air pressure, and relative humidity, usually every 12 hours. The radiosonde data also are plotted on weather maps for various levels in the atmosphere. All this information is exchanged with similar reports from other countries and used in preparing weather charts for forecasting.

Every day in the United States, the National Weather Service and private weather companies prepare and transmit many weather maps. In addition to showing the data, the maps have many lines drawn on them. Similar to terrain contours, these lines connect points of equal values of weather elements. Isobars, discussed earlier, are lines of equal pressure. Lines of equal temperature are called *isotherms*. Other features may be included on weather maps, such as fronts, precipitation, visibility, and cloud types. These elements normally are indicated by special symbols.

The information transmitted to the major weather centers also is entered into computers and used to generate computer models of the atmosphere. These models are different from physical replicas.

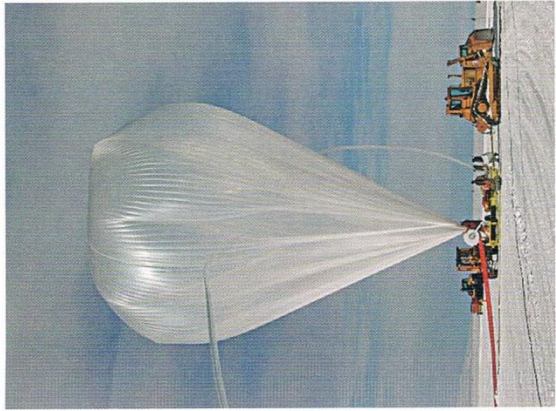

A radiosonde instrument package attached to a weather balloon records data about the temperature, humidity, air pressure, and winds aloft.

Atmospheric models exist only as data in a computer. Weather observations are entered into the computer and processed through mathematical formulas to make what are called numerical weather prediction (NWP) forecasts. NWP forecast information is sent back to the weather offices to be used by weather forecasters.

By using current weather information at the surface and aloft, combined with satellite images of clouds, data from weather radars, and NWP forecasts, meteorologists can make fairly accurate predictions about the weather systems affecting an area. It has been shown that even if meteorologists had perfect models of the atmosphere, there are practical limitations on how well they could forecast the weather. Weather models are not perfect, because it is not possible to take perfect measurements at every point within the entire atmosphere. As everyone knows, forecasts sometimes are wrong. However, weather forecasting is much more accurate than it used to be because of improvements in observing systems, computer technology, and in the scientific understanding of weather events.

Reading Weather Maps

The best way to learn about weather maps is to look at a few. Following are examples of daily weather maps issued by the National Weather Service. Study them carefully. They tell much about the weather. On them, isobars are marked in millibars. Where the lines are far apart, winds tend to be weak. Where they are close together, winds generally are strong.

Note the symbols for the winds at each station. The wind barbs show the direction from which the wind is blowing. The flags and lines show the speeds. A half line is 5 knots, a full line is 10 knots, and a flag is 50 knots. Temperatures are shown in degrees Fahrenheit. Below the temperatures are dewpoint temperatures, also in degrees Fahrenheit.

How to Read a Weather Map

The surface weather maps on the following pages show a sampling of plotted station observations and analyses of pressure, temperature, and front locations.

Cold fronts are shown as heavy solid lines with triangles pointing in the direction in which the cold air is advancing. Warm fronts are shown as lines with solid semicircles pointing in the direction toward which the warm air is moving. Fronts with alternating triangles and semicircles pointing in opposite directions are stationary fronts. Neither the warm air nor the cold is moving very much, so these fronts are hardly moving at all. Sometimes a cold front will overtake a warm front, creating an occluded front. Occluded fronts usually extend from strong, well-developed cyclones. They are shown with alternating triangles and semicircles pointing in the same direction.

Contours of equal pressure, or isobars, are shown as solid lines and are labeled in millibars. Centers of high pressure (anticyclones) and low pressure (cyclones) are indicated by high and low, respectively. Note on the maps how surface winds generally spiral counterclockwise into cyclones and clockwise away from anticyclones. The tracks of well-defined cyclones are shown by a chain of arrows, with previous cyclone center locations shown by small black squares with white crosses. Thick dashed lines show elongated areas of low pressure, or low-pressure troughs.

Areas of precipitation are indicated by shading. Lines of equal temperature (isotherms) are shown for 32 degrees Fahrenheit (thin dashed line) and 0 degrees Fahrenheit (dash-dot line).

Weather maps you access may vary in detail from the maps shown. Simpler versions usually appear in newspaper and television weather reports, while maps analyzed by weather forecasters often are much more detailed. But general features (such as fronts) are shown similarly on most maps using standard symbols like those shown here.

Surface maps and the station model below were provided by the National Oceanic and Atmospheric Administration (NOAA), National Weather Service, Climate Analysis Branch.

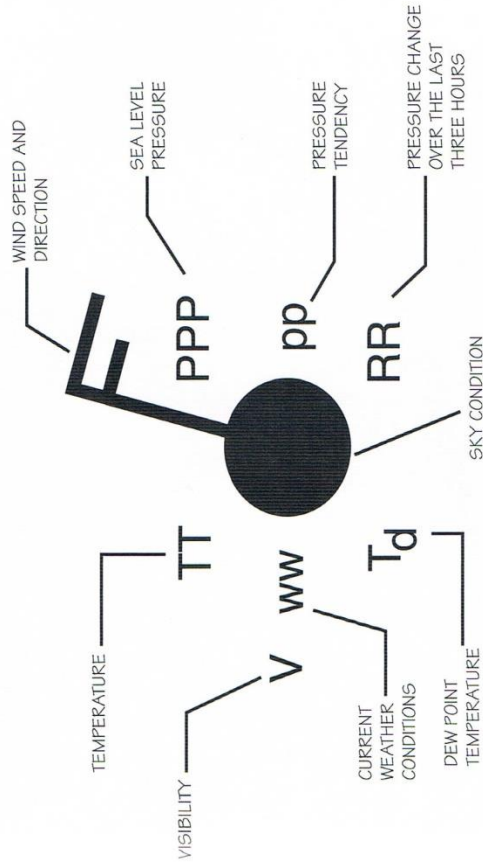

Study this sample plotted station model and compare it with the actual reports on the maps to find station temperatures, winds, pressure, 6-hour rainfall, and so on.

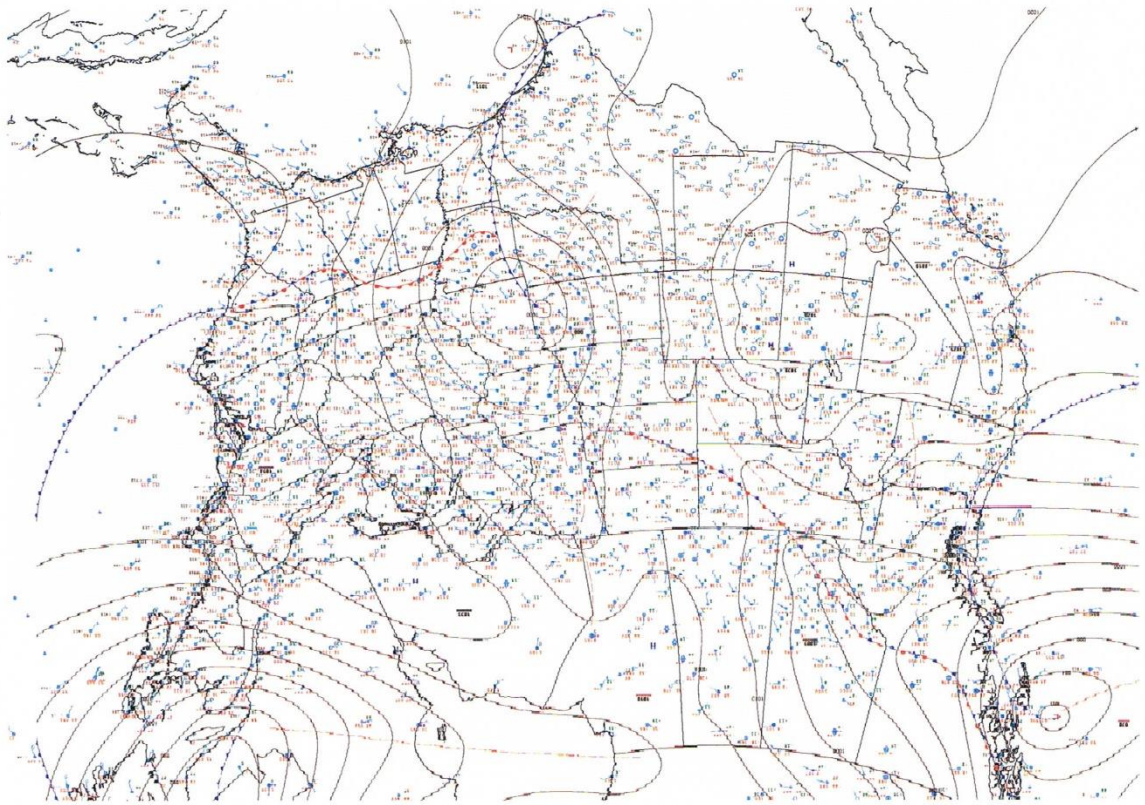
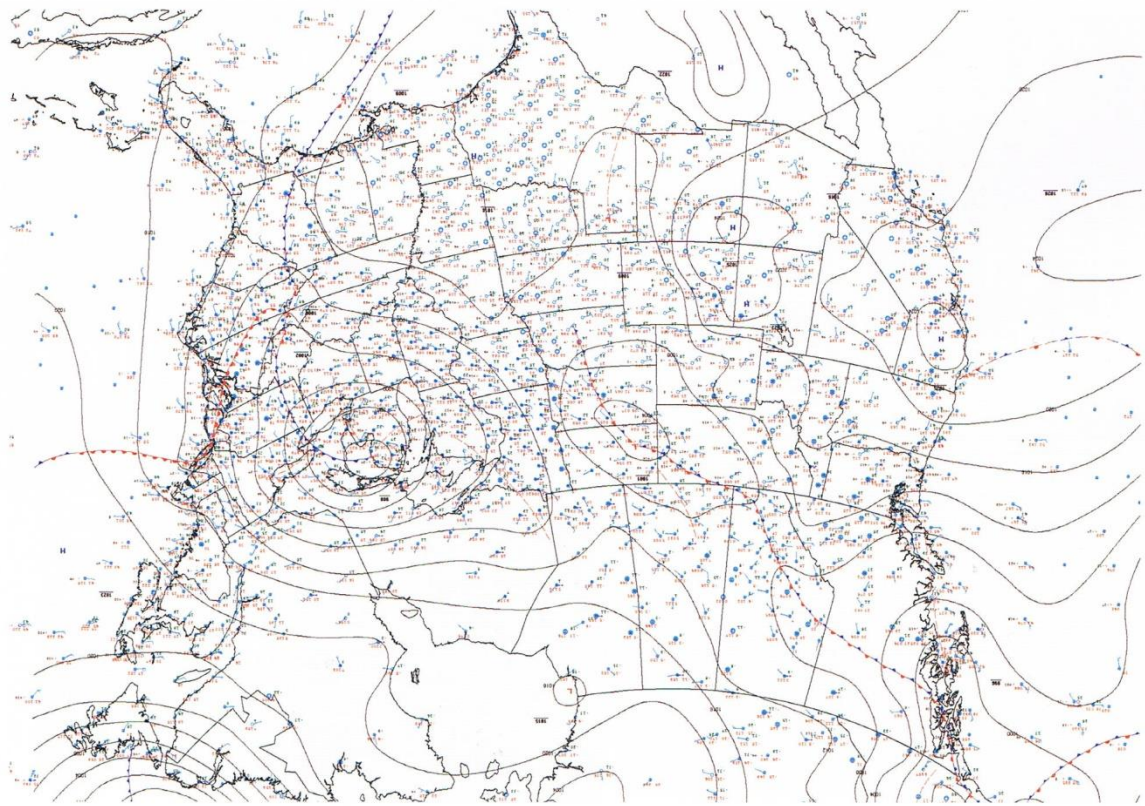

Visit a Weather Office

The National Weather Service has more than 120 offices in the United States and its territories. You should be able to arrange a visit to one while you are working on your Weather merit badge requirements. Alternatively, you might meet with a weather broadcaster at a local television station or an instructor from the meteorology or atmospheric science department at a nearby university or college. There also are many amateur weather observers who can show you the basic measurements, instruments, and weather charts.



You can find the locations of National Weather Service offices by visiting <http://www.weather.gov>.

The most obvious way to study the weather is to observe actual events and keep a record of what you see. Daily observations of temperature, wind, pressure, clouds, and rainfall can help you understand how the atmosphere behaves. Keep a daily weather log, similar to the one shown, for at least a week. If possible, record observations for a month or more. Make entries at the same time each day.

You can obtain readings from your own instruments, from local television or radio, and from Internet sites devoted to meteorology. Up-to-the-minute weather information is also available from the NOAA. NOAA Weather Radio, operating on high-band FM frequencies, transmits updates that can be received by special receivers and by AM/FM radios equipped with a weather-band feature. By comparing readings from day to day, you can see how the various weather elements change at your location in response to passing weather systems.

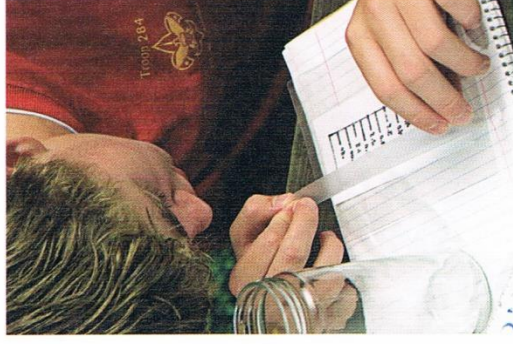

Ask an Expert

Here are a few sample questions you might ask when you talk to a meteorologist for your merit badge requirements. You can come up with your own questions as well.

- What subjects in high school are related to meteorology?
- How can high school students work as interns or student trainees?
- What books and Internet resources do you recommend for learning more about meteorology?
- What kind of degree does a person need to become a meteorologist?
- What career opportunities exist for meteorologists?
- What is the job outlook for meteorologists?
- What kinds of responsibilities do meteorologists have?
- What areas of meteorology do you foresee becoming increasingly important in the next 10 to 20 years?

Daily Weather Log

Observation time: _____

Date	Observed Weather	Temperature	Relative Humidity	Wind (Direction/Speed)	Pressure	24-Hour Rainfall	Forecast for Tomorrow
1							
2							
3							
4							
5							
6							
7							
8							
9							

Make your own weather chart, using this form as a guide. Keep a 30-day record based on local weather forecasts and your own observations. Make and record observations at the same time each day.

Weather and Climate Prediction

The whole of the atmosphere is involved in weather changes. To forecast the weather, a meteorologist must know conditions of temperature, pressure, humidity, and wind throughout the ocean of air, top to bottom and all over the planet. The meteorologist must know about Earth's oceans as well. Because it is hard to obtain information where there are no people, such as over the oceans, there are many gaps in the knowledge used in weather forecasting.

Forecasting Tools and Instruments

Weather Balloons

Early attempts to obtain weather data aloft were made using kites or airplanes that carried recording instruments called *meteorographs* as high as the top of the troposphere. The information recorded on a meteorograph could not be used until the instrument was returned to a weather office.

The balloon-borne radiosonde changed all that. It was responsible for a revolution in understanding the atmosphere. A radiosonde is a small box that contains a barometer, a thermometer, and a hygrometer. Radiosondes are attached to weather balloons that carry them aloft. By tracking the balloons, it is possible to measure wind speed and direction aloft, even where no clouds are present. The practical use of this ability did not become widespread until the development of radio direction-finding devices called *radiotheodolites*. A radiosonde with wind-measurement capability is known as a *rawinsonde*. Rawinsondes typically rise to well above the tropopause, so today it is common to have measurements of all the needed weather variables up to heights of about 100,000 feet.



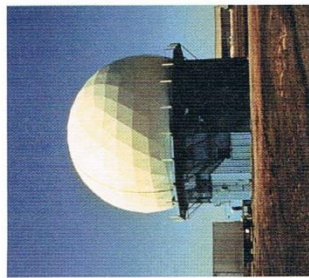

Radar

After World War II, observers noticed that weather seemed to affect radarscopes used for tracking airplanes. They decided that radar might be a good way to detect and track weather targets. The earliest weather radars were converted from military radars in the late 1940s. By 1960, weather radars were in widespread use for tracking precipitation. Basically, the radar beam is sent out from an antenna and is bounced back off objects that the beam strikes. The reflected signal is amplified electronically and displayed in various ways. Radar signals are called echoes because of their similarity to an ordinary sound echo.

By the 1990s, weather radars began to include Doppler equipment (named for the Austrian physicist Christian Doppler). Doppler radars work like police radars to measure the speed of a target and provide information about the speed of precipitation echoes along a radar beam. The radar gives meteorologists helpful information about motions within storms, especially severe thunderstorms that might contain tornadoes.

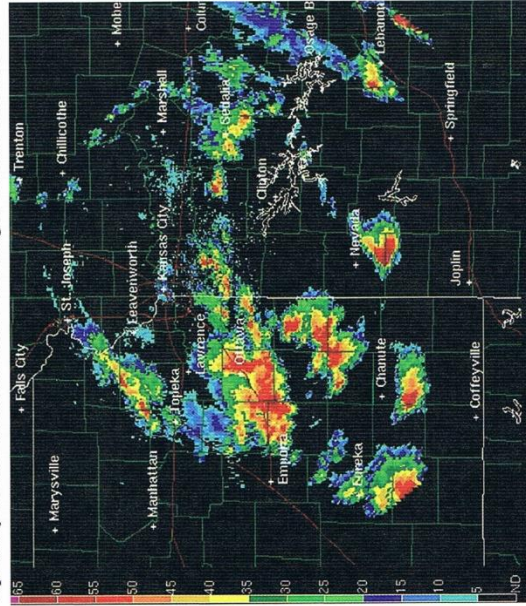

Dark areas on this radar image indicate dry air and colored areas indicate the presence of water vapor. The intensity of precipitation is indicated by spectrum color, with blue meaning light precipitation and red being the heaviest.

Satellites

The first weather satellite, known as TIROS-1, was launched in the spring of 1960. It was highly successful at giving meteorologists their first overall view of entire storm systems.

TIROS satellites were polar orbiters, which means they passed over any one spot on Earth only twice a day. To get a broad view of the whole planet, several pictures had to be pieced together into a composite photograph. A major benefit from such satellites was that tropical cyclones at sea could be spotted and tracked long before they made dangerous landfalls.

Before the age of satellites, meteorologists had to rely on reports from ships at sea that happened upon cyclones. Since 1960, no major tropical cyclone has struck without any warning.

When a satellite is launched into an orbit at the right height (about 22,000 miles) over Earth's equator, it orbits at exactly the same rate at which Earth rotates and thus remains fixed over the same spot. Such an orbit is called a *geosynchronous* orbit. From this lofty height, a satellite surveys a large region. The pictures taken over a period of time from such a satellite can be displayed in sequence to show the cloud motions. Satellite observations are especially important in areas where little or no other information is available, such as over the oceans.

Besides simply taking pictures, the newest geosynchronous satellites (called GOES—geostationary operational environmental satellite) can make sophisticated atmospheric measurements. These measurements allow meteorologists to estimate atmospheric temperature and water vapor content. It is expected that these measurements will become even more sophisticated in the future.

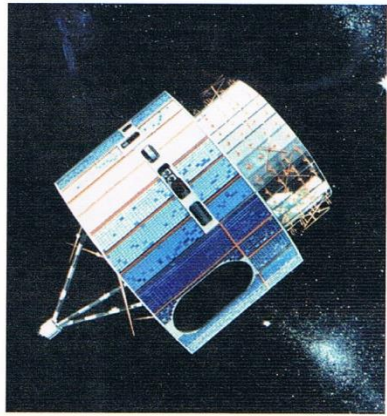

Weather Forecasting—Past and Present

Americans in earlier times did not have much help from weather forecasters until the United States Weather Bureau (the predecessor to today's National Weather Service) became well-established in the late 1800s. As often as not, farmers and sailors had to be their own forecasters. They used all kinds of natural signs as indicators. To predict short-term events, they observed cloud patterns, dew on the grass, winds, and waves. For long-term indications, they studied the hair on caterpillars, the migration patterns of birds, or the hibernation of animals.

In addition to the natural indicators, there were annual almanacs that contained weather forecasts and other information. Predictions published in these books were very general and were based mostly on past weather history. Though their true value was questionable, almanacs have served as the only forecast source for many people through the ages and are still around today.

In recent years, there has been much improvement in science-based weather forecasting. Much of this progress began with World War II. The vast wartime movements of ships, planes, and troops made it necessary for the armed services to have forecasts as accurate as possible far in advance. They set up their own meteorological groups and worked with universities and the U.S. Weather Bureau to develop new techniques. Thousands of men and women received weather training. Many stayed in meteorology after the war and helped pioneer the peacetime application of new ideas.

Advances in electronics technology have made high-speed computers an everyday working tool in many areas, including weather forecasting. The computer made it possible to solve mathematical formulas and equations of meteorology that had been unsolvable before. A completely scientific means for weather forecasting became possible in the 1950s, when the numerical weather prediction (NWP) forecasts were developed. These models are being improved continually.

Climate

Recall that weather is the condition of the atmosphere over a particular area for a short time. *Climate* is the average of the weather over a region for a longer time, such as 30 years or more.

The word *climate* comes from the Greek word *klima*, meaning “angle.” This name was used because the angle at which the sun strikes Earth largely determines the climate. At the equator, the sun is nearly straight overhead most of the year, so most of the equatorial region is hot. In the polar regions, the opposite is true. Poleward from the equator, the climate gradually shifts from hot to cold. In between are what we call the *temperate zones*, which include the United States.

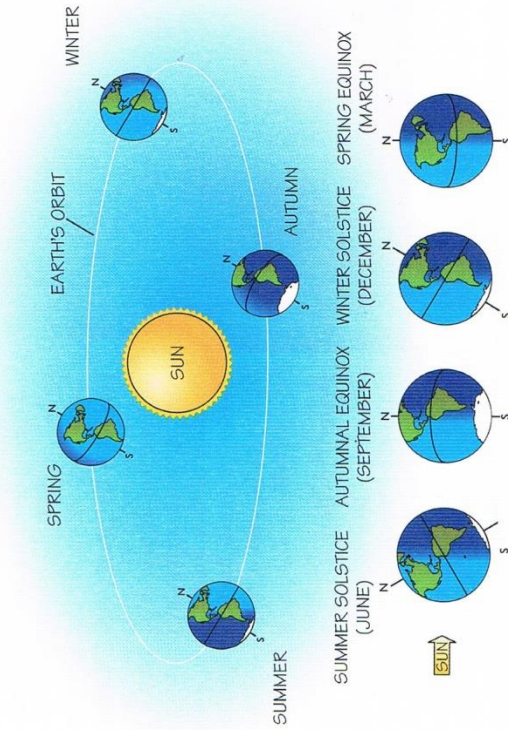

We have seasons because Earth's axis is tilted relative to the plane of its orbit around the sun. This tilt (about 23.5 degrees from the perpendicular) remains the same all year as seen from deep space (top) but changes relative to the sun (bottom). At the summer solstice (the first day of summer, bottom left), the North Pole tilts toward the sun, and the sun reaches its northernmost point in the sky. This is the longest day of the year in the Northern Hemisphere. The North Pole is in constant daylight, while the South Pole is in constant darkness. Everything is reversed at the winter solstice (the first day of winter, bottom, second from right). The South Pole tilts toward the sun, and the Southern Hemisphere has long days and warm weather as the sun appears at its southernmost point in the sky. In between, during the autumnal equinox and spring equinox, sunshine is evenly distributed across both hemispheres.

Many other factors influence climate, of course. No definite rule can be made for a part of the world simply because it is a certain distance from the equator. Altitude affects climate, for example. In Peru at 10,000 feet to 15,000 feet above sea level, the sun can make it quite warm during the day, but at night it gets very cold. Many high peaks are covered in snow all year, despite their location close to the equator.

Ocean currents can make a major difference as well. England is as far north as part the Canadian province of Newfoundland and Labrador, but the warm waters of the Gulf Stream moderate the winters in England so that they are warmer on average than those in New York City, which is significantly south of England.

Climate information helps experts layout airport runways and determine heating and cooling needs for houses, factories, or for the shipment of goods.

Human Impacts on Climate

An important thing to think about is the effect present human activities can have on future climatic conditions. In some areas of the world, human actions have had a clearly negative impact on the local climate.



Desertification

The work of archaeologists has shown that many areas that now are deserts once were fertile and productive. In such places, overgrazing, unsound farming methods, or mining have stripped the land of its protective plant cover and caused desertification of the land.

Desertification has occurred in many countries near the Mediterranean Sea and the Arabian Desert. For example, the region north of Egypt and Egypt itself once had lush fields, orchards, and gardens, but over many years human activities resulted in the erosion of fertile topsoil and the loss of plant cover. A cycle began that produced parched soil, sand dunes, and scant rainfall. Similar events have occurred in the United States, such as during the "Dust Bowl" era of the 1930s, but changes in agricultural methods may have kept the effects from becoming permanent.

Acid Rain

Acid rain is another result of the effect human activities can have on weather and climate, some scientists believe. Rain becomes acidic when it is polluted by acidic substances emitted into the atmosphere by vehicles, power plants, and factories. Pollutants in the atmosphere contaminate the precipitation that later falls back to the ground. Scientists say acid rain can destroy life in lakes and rivers, which results in damage to the water cycle, crops, forests, outdoor statues, and buildings.

Other Threats to Climate

Recently, people worldwide have become aware of the possible threat of greenhouse gases. The most notable greenhouse gas is carbon dioxide, given off when fossil fuels such as coal, gas, and oil are burned.

Although meteorologists and climatologists do not know exactly what effect the greenhouse gases will have, it appears that excess carbon dioxide and other gases might trap more of the sun's heat and cause the climate all over the globe to warm up. Some scientists believe *global warming* could have disastrous effects. For instance, the polar ice caps reflect the sun's rays and are essential in keeping Earth's climate as it is. If the ice caps melt, even a small amount, these scientists say Earth's temperature, weather patterns, and the amount of water in the oceans may change. Many islands and seacoasts could be flooded permanently.

Another concern is the loss of the ozone layer. Ozone is a pale blue gas that plays an important role in the stratosphere, where it acts to shield all forms of life on Earth from the sun's harmful ultraviolet radiation. Damage to the ozone layer appears to be the result of chemicals called *chlorofluorocarbons* (CFCs), once used as propellant in aerosol cans, as refrigerants in air conditioners, and as solvents in certain industrial processes. Although recent laws have greatly reduced the use of CFCs, some scientists are not certain the ozone layer will recover.



Another source of carbon dioxide is the clearing and burning of trees in the rain forests of the world.

The hole in the ozone layer permits ultraviolet radiation from the sun to reach the surface in increased amounts, which may contribute to global warming and climate change.

In general, conservation of resources, such as fossil fuels and the world's forests, can be of long-term benefit by lessening the effects of human activities on the global climate.

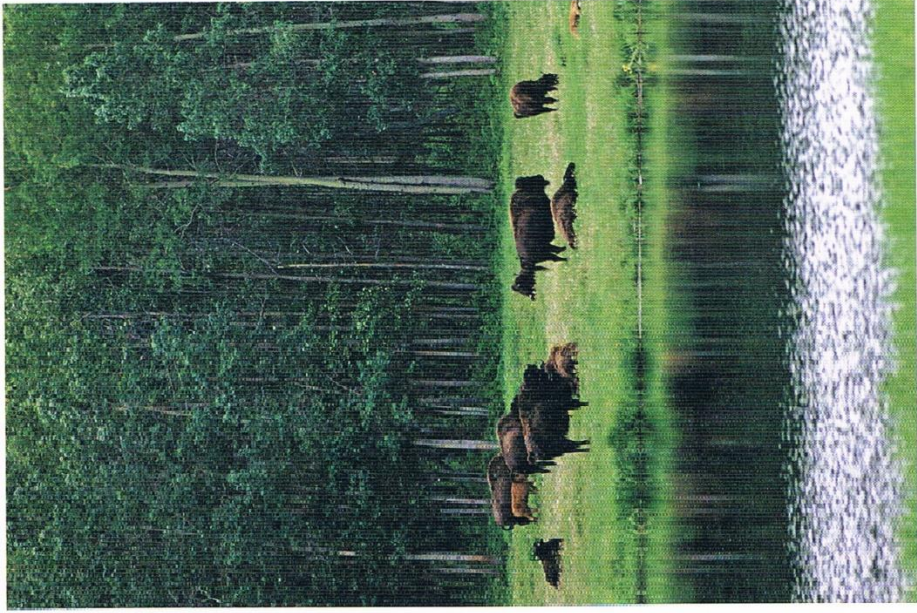

Water conservation and careful agricultural and mining practices also can help preserve the natural balance of things.

Weather Affects All of Us

A rainy day will keep you from mowing the lawn or playing a baseball game. A serious heat wave could prevent your Scout troop from taking a hiking trip. For people in some occupations, however, the weather forecast is vital. Planning ahead for weather conditions can mean the difference between profit and loss or even life and death.

Climate information helps experts lay out airport runways and determine heating and cooling needs for houses, factories, or for the shipment of goods. Climate records may be introduced as evidence in court to clarify the causes of accidents on highways, in the air, and at sea. Climate can affect people's health and social behavior as well as agricultural, commercial, and industrial pursuits the world over. Here are a few examples:

Aviators. Pilots need accurate, up-to-date forecasts to help them make decisions such as whether to land a plane. If a destination airport is fogged in or has icy runways, the pilot may delay departure or land at a different airport. If there is a thunderstorm brewing along the planned route, a pilot can take an alternate route. Pilots also take advantage of good weather, letting the tailwind push the plane along to save fuel.

Sailors. Being caught far out at sea during severe weather poses great danger to sailors. Knowing the forecast can help sailors avoid areas of high wind and other trouble. Sailors can plan alternative routes to their destinations or choose safe areas in which to work (fishing, for instance) when they have information about the weather.

Farmers. Farmers know the importance of wind, rain, and temperature on their plants and animals. An early frost can ruin a citrus crop. A bitterly cold winter or a very wet season can reduce the weight gain of livestock. Farmers plan when to sow, weed, and harvest according to the day-to-day weather forecast. They also plan what crops to grow according to the seasonal forecast. For instance, a rice crop that needs wet conditions while it grows and dry conditions while it ripens.

Outdoor Construction Workers. Builders and other people in the field of construction pay close attention to weather forecasts. Road-paving crews, roofers, painters, and others cannot do their work successfully in the rain. Wind can endanger those who must keep their balance high above the ground. Many building materials such as paint may be used effectively only within certain limits of humidity and temperature.

Careers in Meteorology

The meteorologists you probably are most familiar with are the weather newscasters on television. But there are many additional career opportunities for meteorologists.

Research and Teaching

Researchers work to further develop satellites, computer programs, mathematical formulas, and other instruments used in forecasting, analyzing, and collecting data related to climate and weather. Such researchers work for universities, private industry, and the U.S. government. The National Aeronautics and Space Administration (NASA) is just one government agency that uses researchers. Many researchers analyze levels of pollution in the oceans and atmosphere. At the National Center for Atmospheric Research (NCAR), climate research is a high priority. At universities, meteorology professors teach and conduct research. Their research is usually supported by grants from the government or private foundations.

Forecasting

Weather forecasting is formally known as operational meteorology. Many forecasters work for the National Weather Service (a branch of the NOAA), which includes the National Center for Environmental Prediction as well as 124 field offices across the country. The National Weather Service is a government agency that gathers information from weather balloons, satellites, and observation stations around the world. People and computers at the National Weather Service analyze and interpret the gathered data to produce forecasts.

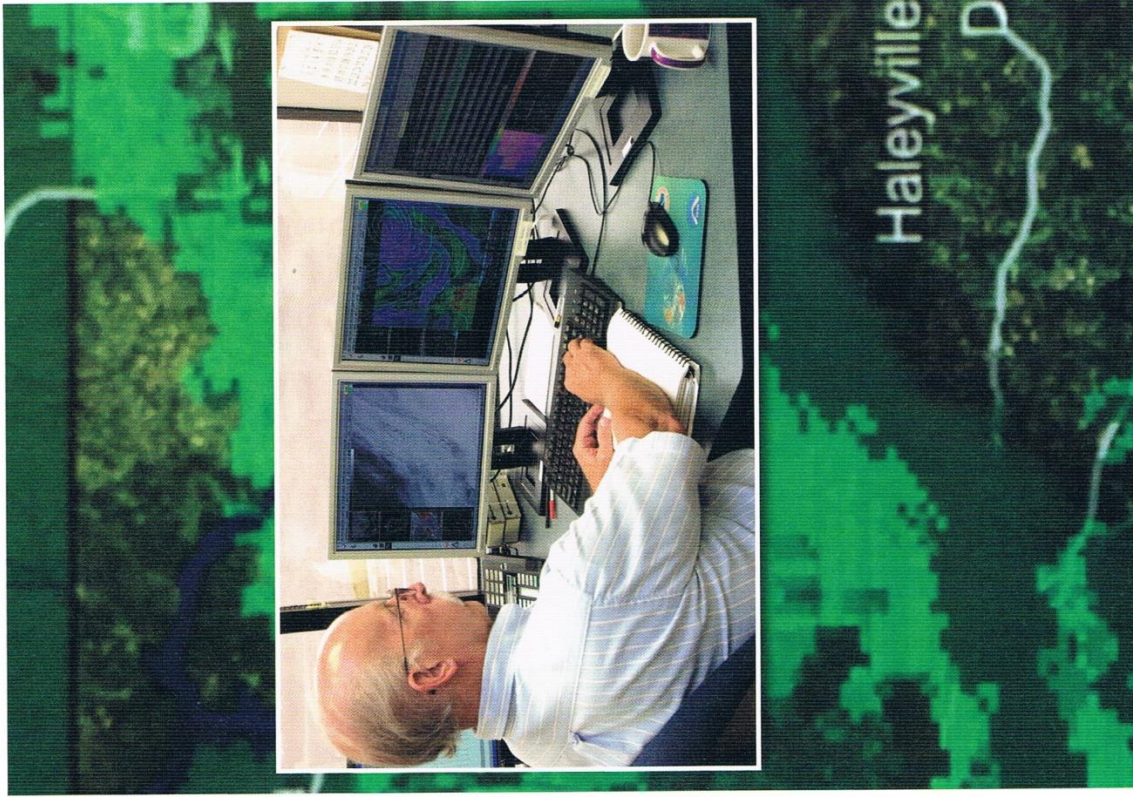

The U.S. military also employs meteorologists to help plan operations on the ground, in the air, and at sea. Weather forecasts help Army troops know when to travel and help Air Force aviators plan their flights. Naval meteorology and oceanography often go hand in hand, as the Navy needs to predict conditions under the water as well as above it.

Other forecasters work for private organizations, such as AccuWeather, that interpret data from NOAA and then sell their specific analyses to newspapers, radio and television stations, and industries such as aviation, construction, and farming. Private forecasting companies supply newspapers with full-color weather maps and the forecasts that radio stations broadcast. Industries that purchase forecasts use them to determine how the weather could affect airplane flights, outdoor painting, and crop harvests.

Qualifications

What knowledge and skills do you need to work in meteorology and its related fields? This list gives you some guidelines for what it takes to become a meteorologist.

- You will need a good foundation in science and mathematics. Take these classes seriously while you are in middle school and high school.
- You will need a bachelor's degree in meteorology (also called atmospheric sciences) or a related field, such as physics. You will need to take classes in thermodynamics and calculus. Those classes are required by the National Weather Service, no matter which branch of meteorology you plan to pursue.
- If you would like to become a television weather reporter, you will need to develop strong communications skills. You also will probably have to start your career in a small market, that is, a small city or community. In other words, forecasting for Los Angeles or New York City will probably not be your first job.
- Forecasters work in shifts that often require them to work nights and weekends. During weather emergencies, these meteorologists may have to put in extra hours.

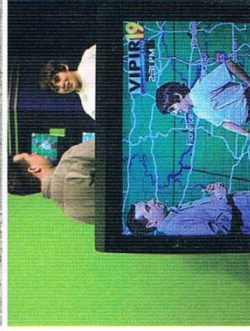
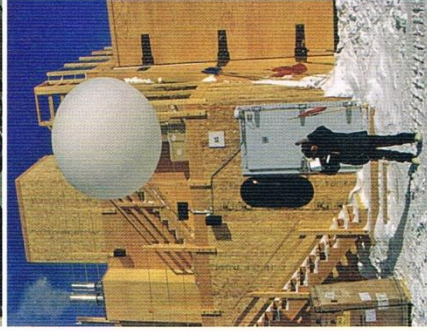
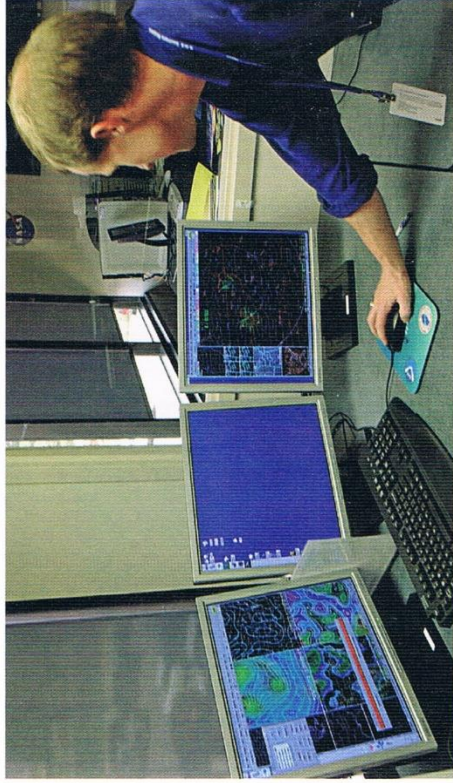

Weather Resources

Scouting Literature

Basic Illustrated Weather Forecasting: Fieldbook; Chemistry, Emergency Preparedness, Environmental Science, and Oceanography merit badge pamphlets

Visit the Boy Scouts of America's official retail website at <http://www.scoutstuff.org> for a complete listing of all merit badge pamphlets and other helpful Scouting materials and supplies.

Elson, Derek M. *Weather Explained: A Beginner's Guide to the Elements*, Vol. 5. Henry Holt & Company, 1997.

Gardner, Robert, et al. *Science Projects About Weather*. Enslow Publishers, 1994.

Kahl, Jonathan D. *W. National Audubon Society First Field Guide: Weather*. Scholastic, 1998.

Moran, Joseph M., et al. *Meteorology: The Atmosphere and Science of Weather*. Prentice Hall, 1996.

Petheram, Louise. *Acid Rain*. Bridgestone Books, 2002.

Books

Burt, Christopher C. *Extreme Weather: A Guide and Record Book*. W. W. Norton, 2004.

Ceban, Bonnie J. *Tornadoes: Disaster and Survival*. Enslow Publishers, 2005.

Chaston, Peter R. *Weather Maps: How to Read and Interpret All the Basic Weather Charts*. Chaston Scientific Inc., 2002.

Cosgrove, Brian. *Weather*. DK Publishing, 2004.

Day, John A., and Vincent J. Schaefer. *Clouds and Weather: The Concise Field Guide to the Atmosphere*. Houghton Mifflin, 1998.

Magazines

Weatherwise: The Magazine About Weather

1319 18th St., NW
Washington, DC 20036-1802
Website: <http://www.weather-wise.org>

Organizations and Websites

Career Guide for the

Atmospheric Sciences

Website: <http://www.ametsoc.org/atmoscareers/index.html>

Earth Watch Weather on Demand

Website: <http://earthwatch.com>

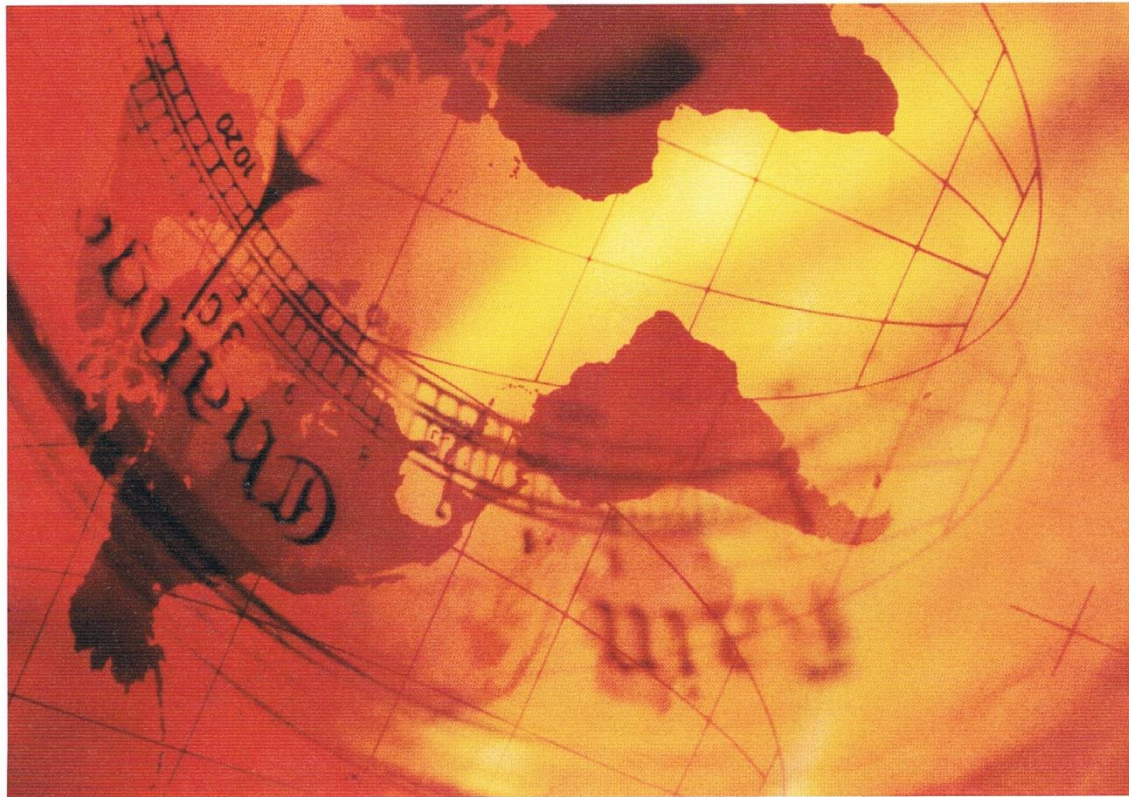



Lightning Protection Institute

P.O. Box 6336
St. Joseph, MO 64506
Toll-free telephone: 800-488-6864
Website: <http://www.lightning.org>

Satellite Meteorology for Grades 7-12

Website:
<http://cimss.ssec.wisc.edu/satmet>

The National Center for Atmospheric Research and the UCAR Office of Programs

P.O. Box 3000
Boulder, CO 80307-3000
Website: <http://www.ucar.edu>

The National Oceanic and Atmospheric Administration's National Weather Service

1325 East West Highway
Silver Spring, MD 20910
Website: <http://nws.noaa.gov>

Acknowledgments

The Boy Scouts of America thanks Kerry M. Jones, senior forecaster with the National Weather Service in Albuquerque, New Mexico. Mr. Jones diligently provided his expertise, time, and other resources for this new edition of the *Weather* merit badge pamphlet. We appreciate his thoroughness and his attentiveness during this lengthy project.

We appreciate the Quicklist Consulting Committee of the Association for Library Service to Children, a division of the American Library Association, for its assistance with updating the resources section of this merit badge pamphlet.

Photo and Illustration Credits

HAAP Media Ltd., courtesy—cover (leaf, weather vane, clouds, analog barometer); pages 45 (both) and 80

©Jupiterimages.com—page 26

NASA, courtesy—cover (*Earth*) and page 30

National Oceanic and Atmospheric Administration, Department of Commerce/Grant W. Goodge, courtesy—page 19 (bottom)

National Oceanic and Atmospheric Administration, Department of Commerce/Historic NWS Collection, courtesy—page 38

National Oceanic and Atmospheric Administration, Department of Commerce/Ralph F. Kresge, courtesy—pages 22 (bottom), 23 (bottom), and 24 (top right)

National Oceanic and Atmospheric Administration, Department of Commerce/National Weather Service, courtesy—page 64 (bottom)

National Oceanic and Atmospheric Administration, Department of Commerce/Michael Theberge, Maine Maritime Academy, courtesy—page 17

National Oceanic and Atmospheric Administration, Department of Commerce/Don Whelpey, courtesy—page 25 (top)

New York State Department of Environmental Conservation, courtesy—page 69

NOAA Photo Library, NOAA Central Library; OAR/ERL/National Severe Storms Laboratory (NSSL), courtesy—page 27

©Photos.com—cover (penguins); pages 3-4 (all), 6-7 (both), 8 (inset), 14, 19 (top, center left, center right), 20, 23, 24 (bottom), 25 (center, bottom), 39 (bottom), 68, 70, and 76

Wikipedia.org, courtesy—pages 24 (top left) and 78

All other photos and illustrations not mentioned above are the property of or are protected by the Boy Scouts of America.

Daniel Giles—pages 18, 40, 46-47 (all), 51, 60-61, 72 (both), and 75 (top, bottom left)

John McDearmon—all illustrations on pages 10-13, 16, 21, 29, 34-35, 39, 42, 50, 52, and 67

Brian Payne—pages 32 and 36

Brad Range—pages 54, 62, and 75 (center left, bottom right)

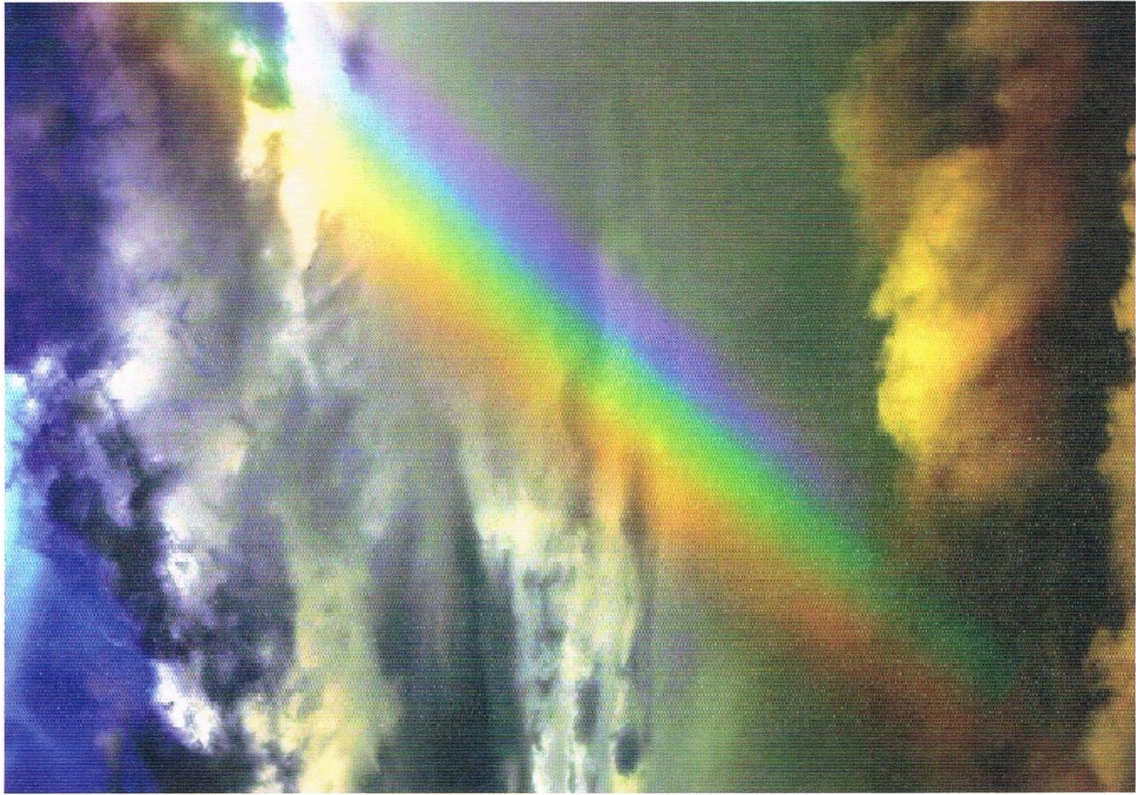

MERIT BADGE LIBRARY

Though intended as an aid to Boy Scouts, Varsity Scouts, and qualified Venturers and Sea Scouts in meeting merit badge requirements, these pamphlets are of general interest and are made available by many schools and public libraries. The latest revision date of each pamphlet might not correspond with the copyright date shown below, because this list is corrected only once a year, in January. Any number of merit badge pamphlets may be revised throughout the year; others are simply reprinted until a revision becomes necessary.

If a Scout has already started working on a merit badge when a new edition for that pamphlet is introduced, *he may continue to use the same merit badge pamphlet to earn the badge and fulfill the requirements therein.* In other words, the Scout need not start over again with the new pamphlet and possibly revised requirements.

Merit Badge Pamphlet	Year	Merit Badge Pamphlet	Year	Merit Badge Pamphlet	Year
American Business	2002	Entrepreneurship	2006	Plant Science	2006
American Cultures	2005	Environmental Science	2006	Plant Science	2005
American Heritage	2005	Family Life	2005	Plumbing	2004
American Labor	2006	Farm Mechanics	2008	Pottery	2008
Animal Science	2006	Fingerprinting	2003	Public Health	2005
Archaeology	2006	Fire Safety	2004	Public Speaking	2002
Archery	2004	First Aid	2007	Pulp and Paper	2006
Architecture and Landscape Architecture	2010	Fish and Wildlife Management	2004	Radio	2008
Art	2006	Fishing	2009	Railroading	2003
Astronomy	2010	Fly-Fishing	2009	Reading	2003
Athletics	2006	Forestry	2005	Reptile and Amphibian Study	2005
Automotive Maintenance	2008	Gardening	2002	Rifle Shooting	2001
Aviation	2006	Genealogy	2005	Robotics	2011
Backpacking	2007	Geocaching	2010	Rowing	2006
Bakery	2003	Geology	2005	Safety	2006
Bird Study	2005	Golf	2002	Salesmanship	2003
Bugling (see Music)	2005	Graphic Arts	2006	Scholarship	2004
Camping	2005	Hiking	2007	Scouting Heritage	2010
Canoeing	2004	Home Repairs	2009	Scuba Diving	2009
Chemistry	2004	Horsemanship	2010	Sculpture	2007
Chess	2011	Indian Lore	2008	Shotgun Shooting	2005
Cinematography	2008	Insect Study	2008	Skating	2005
Citizenship in the Community	2005	Inventing	2010	Small-Boat Sailing	2004
Citizenship in the Nation	2005	Journalism	2006	Snow Sports	2007
Citizenship in the World	2005	Landscape Architecture (see Architecture)	2006	Soil and Water Conservation	2004
Climbing	2006	Law	2003	Space Exploration	2004
Collectors	2008	Leatherwork	2002	Sports	2006
Communication	2009	Lifesaving	2008	Stamp Collecting	2007
Composite Materials	2006	Mammal Study	2003	Surveying	2004
Computers	2009	Medicine	2009	Swimming	2008
Cooking	2007	Metalwork	2007	Textile	2003
Crime Prevention	2005	Model Design and Building	2010	Theater	2005
Cycling	2003	Motorboating	2008	Traffic Safety	2006
Disabilities Awareness	2005	Nature	2003	Truck Transportation	2005
Dog Care	2003	Nuclear Science	2010	Veterinary Medicine	2005
Drawing	2008	Oceanography	2009	Water Sports	2007
Electricity	2004	Orienteering	2003	Weather	2006
Electronics	2004	Painting	2008	Welding	2012
Emergency Preparedness	2008	Personal Fitness	2006	Whitewater	2005
Energy	2005	Personal Management	2003	Wilderness Survival	2007
Engineering	2008	Pets	2003	Wood Carving	2006
		Photography	2005	Woodwork	2011

BOY SCOUTS OF AMERICA • SUPPLY GROUP

NATIONAL DISTRIBUTION CENTER
2109 Westinghouse Boulevard

P.O. Box 7143

Charlotte, NC 28241-7143

www.scoutstuff.org

DIRECT MAIL CENTER

P.O. Box 909

Pineville, NC 28134-0909

For fast credit card orders—
VISA, MasterCard, American Express—

call BSA operators toll-free

1-800-323-0732